

# PoolWarehouse

1-800-515-1747 FAX: 888-491-1236  
sales@poolwarehouse.com

**PLEASE RETURN THIS FORM VIA EMAIL OR FAX.**

## Pool Cover Form

### CUSTOMER IS RESPONSIBLE FOR THE PROPER FIT!

By the submission of this order the below named corporation and individual hereby authorize PWH and HYDRA COVERS to manufacture as a special order, a pool cover for an in-ground pool in accordance with the design and specifications which have been provided here within, and hereby acknowledge that PWH and HYDRA COVERS have not participated in either the design or formation of this liner and accepts full responsibility for the same, and further agrees to hold PWH and HYDRA COVERS harmless, that is, the below named corporation will pay in full or for any and all claims and expenses that may arise out of the design or use of this special cover.

### PLEASE CHECK THE COVER(S) YOU WOULD LIKE US TO QUOTE FOR YOU:

#### MESH SAFETY COVERS

Mesh covers are usually lighter and easier to handle than solid covers. This means it will be easier to get the safety cover on and off your pool. Mesh covers will also allow rain water and melting snow to pass through the cover into the pool. Most of the time, covers are going to be less expensive than solid covers.

- GLI Secure-A-Pool
- GLI ProMesh
- Hydra Mesh

#### SOLID SAFETY COVERS

The big advantage of a solid cover is that it will prevent sunlight and fine particles from entering the water. This will prevent dirt and algae from building up in the pool, keeping it cleaner over the winter. With solid covers, you must remove standing water from the top with either a drain panel (mesh built into the cover), or a cover pump.

- Hydra-Lite       Drain  Pump
- Hydra Heavy Weight    Drain  Pump
- GLI HyperPerLite       Drain  Pump

Name:

Address:

City:  State:

Zip:  Phone:

E-Mail:

Signature:

COVER COLOR OPTIONS:     Blue       Green       Tan

### DETERMINE YOUR POOL TYPE:

**TYPE #1 POOL** - Rectangle, Rectangle with Step, Grecian, Roman or L-Shaped

**TYPE #2 POOL** - Round, Free Form, Oval, Kidney or Lazy L

### IMPORTANT:

Original cover, pool size, and distances between anchors along with anchor count is needed to produce an exact replacement. If you do not have the old cover and it is a Type 2 pool, then both the pool and anchor points need A-B measurements for an exact replacement.

Use the following pages of this guide to help you make accurate measurements of your pool.

**PLEASE READ ALL DIRECTIONS CAREFULLY BEFORE MEASURING YOUR POOL!**

### SHIPPING INSTRUCTIONS

Name:

Address:

City:  State:

Zip:  Phone:

E-Mail:

Mark Box:

### TYPE 1 POOLS

#### STEP 1:

Using the graph paper provided, draw an accurate diagram that shows the inside pool dimensions. Include the deck area, planters, and any other obstructions that are within 18" of the waterline. If you have a rock structure on the waterline, a raised wall, or a waterfall, please use Type #2 instructions for A - B measurements. If you are replacing a safety cover, and the old cover is not available, please use Type 2 instructions for A-B measurements as well.

#### STEP 2:

The diagrams below show the required measurements for each type of pool shape. Select the shape that most closely matches your particular pool, and list your measurements accordingly here & on the diagram you created. Be sure they are inside waterline dimensions! If your pool doesn't match a shape you see below, you may need to measure for a Type 2 pool.

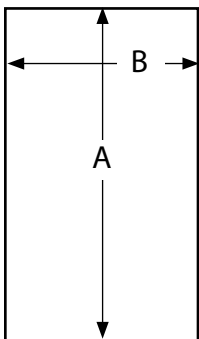

Rectangle

A  ft  in

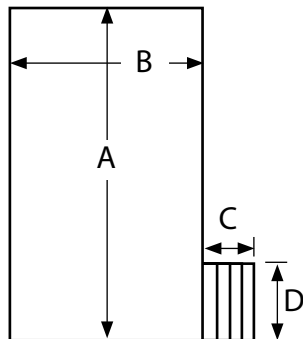

Rectangle w/Step

B  ft  in

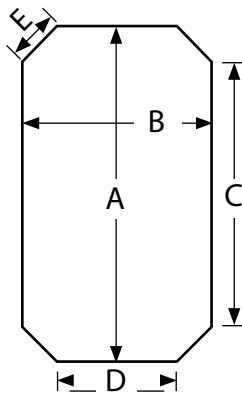

Grecian

C  ft  in

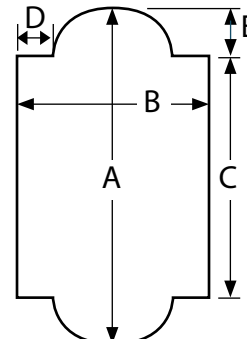

Roman

D  ft  in

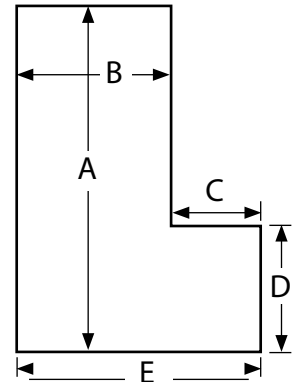

L-Shaped

E  ft  in

## TYPE 2 POOLS

Name:

### STEP 1:

Using the graph paper provided, draw an accurate diagram indicating the inside pool dimensions. Include the deck area, planters, and any other obstructions that are within 18" of the waterline. Photographs of the pool are required when you have rocks, waterfalls, raised walls, spas, or anything other than a simple, unbroken coping perimeter.

### STEP 2:

Establish two points to be called A and B, parallel to the long side of the pool. These points should be at least 25 feet apart (or 2/3 the total length of the pool), and able to be easily marked with masking tape (or stakes if in the lawn). A must be to the left of B as you face the pool. Be sure to provide the distance between A and B as you face the pool.

Note: The A-B line must never intersect the pool and must be at least 4 feet away from any marked point (pool, anchors, and obstructions) regardless of how far back the line needs to be extended.

### STEP 3:

Using masking tape and waterproof marker, mark and number points along the inside edge of the pool at a maximum of 2 foot intervals. Be sure to identify all non-removable obstruction points when filling in your measurements on the measuring chart provided. Always number in a clockwise direction.

Note: Use masking tape and waterproof marker instead of chalk. Chalk will wash away if it rains, but the tape and marker will stay put.

Number all corner points, direction changes, ladders, handrails, grab rails, slide legs, rocks, spillways, spa walls that separate the spa and pool, fill spouts, and dive stands that are not removable. **IMPORTANT:** Also number any anchors from a previous safety cover. 1 foot intervals should be used in small or tight radius areas. Remember to include the total length of your A-B line, along with the overall length of your pool.

### STEP 4:

Provide cross dimensions from numbered points. These are important so we can verify whether they match the A-B measurements of your pool.

## A-B MEASUREMENTS

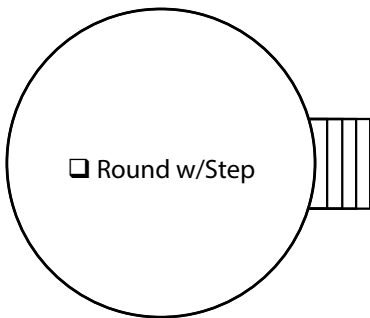

A ← 25' → B

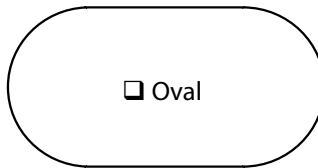

A ← 25' → B

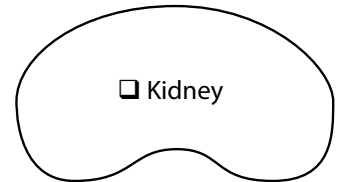

A ← 25' → B



A ← 25' → B

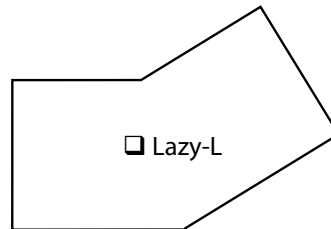

A ← 25' → B

Refer to the following **TYPE 2 POOL A-B MEASURING METHOD INSTRUCTIONS** page.  
It contains detailed instructions on how to correctly measure and record the measurements of your pool.

# TYPE 2 POOL A-B MEASURING METHOD INSTRUCTIONS

Name:

NOTE: For customers looking to match existing anchors you will need to measure BOTH the pool and the anchors from the same A-B line. The A-B line should be positioned 4-5 feet behind the anchors. You will need to submit two measurement sheets.

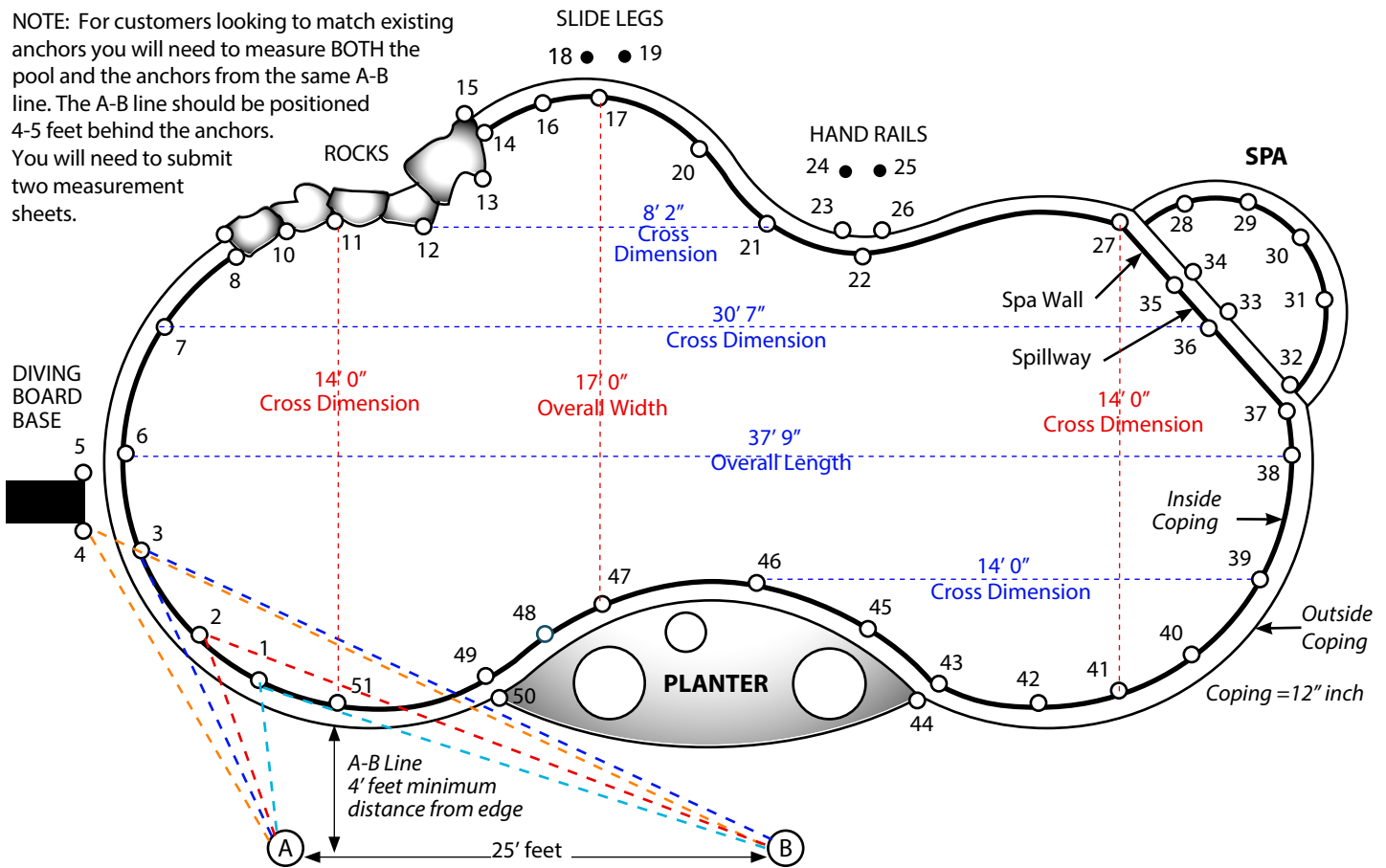

1. Using chalk, establish two points "A" and "B", roughly three to four feet from the edge of the pool at least half the length of the pools distance (usually 20 ft – 25 ft in length). When facing the pool, Point A must be on your left and Point B on your right (see drawing). The "A-B" Line must not cross the edge or water of the pool. All measurements from the numbered points must touch point A and B at exactly the same point.

**Record the distance measurement of A-B in the space indicated on the measuring form.**

2. Using chalk, make a mark and number points at the edge of the coping, two feet apart around the perimeter of the pool. Include all non-removable objects within 3 feet of the pool's edge.

3. Next, measure the distance between Point "A" and Point "1" then "A" to point "2" and so on... until you have gone all the way around the pool.

**Record each measurement on the A-B Measurement Sheet.**

4. Now measure the distance from POINT B to all of the numbered points, using the same process that you did for Point "A".

**Record each measurement on the A-B Measurement Sheet.**

5. Finally, measure the overall width and length of the pool by selecting numbered points that represent these distances. It is also helpful if you provide four Cross Dimension measurements 2 for the width and 2 for the length of the pool. (See drawing).

**Record each measurement on the A-B Measurement Sheet.**

## A-B Measurement Sheet Examples

Point No.	TO A	B
1	5' 2"	27' 6"
2	8' 4"	29' 2"
3	11' 8"	32' 6"
4	15' 8"	36' 6"
5		

IMPORTANT:	
the distance from POINT A to POINT B	25 Ft. 0 In.

Point No.	TO Point No.	Feet	Inches
<b>OVERALL POOL WIDTH</b>			
17	47	17'	0"
<b>OVERALL POOL LENGTH</b>			
6	38	37'	9"
<b>CROSS DIMENSION</b>			
7	36	30'	7"

# TYPE 2 POOL COVER A-B MEASUREMENT SHEET

Name:

Point No.	TO	ft	A	in	ft	B	in
1							
2							
3							
4							
5							
6							
7							
8							
9							
10							
11							
12							
13							
14							
15							
16							
17							
18							
19							
20							
21							
22							
23							
24							
25							
26							
27							
28							
29							
30							
31							
32							
33							
34							
35							
36							

Point No.	TO	ft	A	in	ft	B	in
37							
38							
39							
40							
41							
42							
43							
44							
45							
46							
47							
48							
49							
50							
51							
52							
53							
54							
55							
56							
57							
58							
59							
60							
61							
62							
63							
64							
65							
66							
67							
68							
69							
70							
71							
72							

IMPORTANT:	
the distance from	
<b>POINT A to POINT B</b>	ft in

Point No.	TO	Point No.	Feet	Inches
<b>OVERALL POOL WIDTH</b>				
<b>OVERALL POOL LENGTH</b>				
<b>CROSS DIMENSION</b>				
<b>CROSS DIMENSION</b>				
<b>CROSS DIMENSION</b>				
<b>CROSS DIMENSION</b>				

A/B	TO	Point No.	Feet	Inches
<b>NON-REMOVABLE OBSTRUCTION 1</b>				
<b>TYPE:</b>				
<b>A to</b>				
<b>B to</b>				
<b>NON-REMOVABLE OBSTRUCTION 2</b>				
<b>TYPE:</b>				
<b>A to</b>				
<b>B to</b>				
<b>NON-REMOVABLE OBSTRUCTION 3</b>				
<b>TYPE:</b>				
<b>A to</b>				
<b>B to</b>				
<b>NON-REMOVABLE OBSTRUCTION 4</b>				
<b>TYPE:</b>				
<b>A to</b>				
<b>B to</b>				

*If you have more than 4 obstructions please provide this information on an additional sheet.*

**NOTES:**

**STEPS:**

If you have a step section, be sure to provide step length and width, and the offset of the step if applicable. Please provide any measurements given for obstructions on the diagram that is completed.

Name:

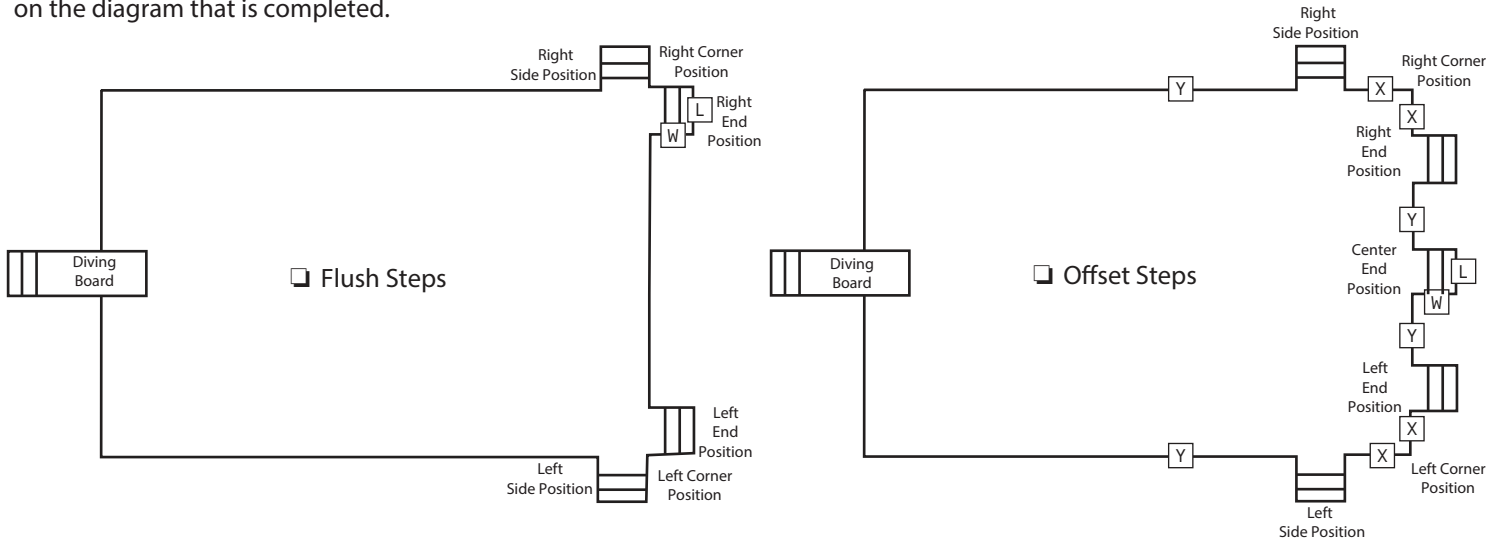

**A. Step Section Size:**

(L) Length  ft  in    (W) Width  ft  in

**B. Offset Steps – Distance of step from corners:**

(X)  ft  in    (Y)  ft  in

Step Length (L): Measure across one step from side to side. Step Width (W): Measured from the water's edge to the back of the step section.

**LADDERS & OBSTRUCTIONS:**

If you have any non-removable obstructions within 18" of the waterline, locate them on your diagram. Measure the distance from the obstruction to the pool's edge, and also measure the distance from the obstruction to the closest squared off corner of the pool.

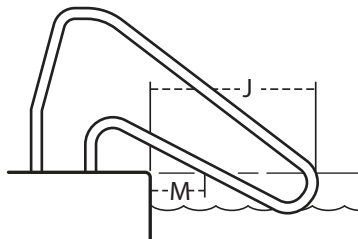
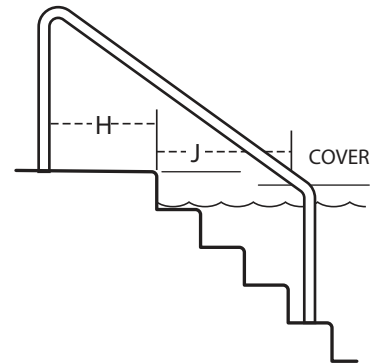
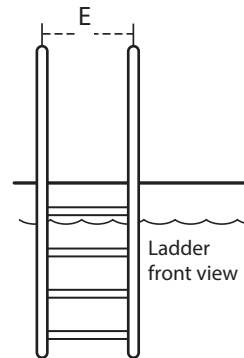
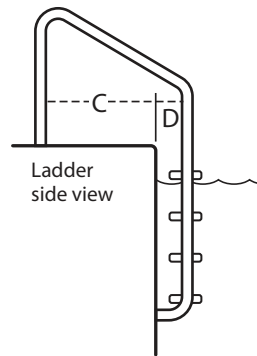
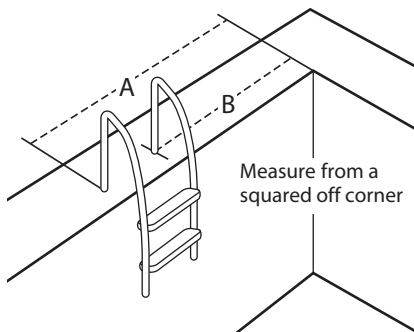

**EXAMPLE:  
Non-Removable  
Obstructions**

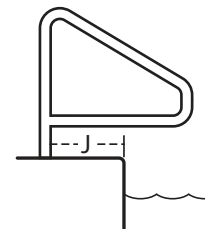
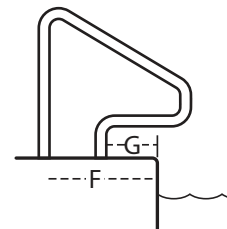

A  ft  in    B  ft  in    C  ft  in    D  ft  in    E  ft  in  
 F  ft  in    G  ft  in    H  ft  in    J  ft  in    M  ft  in

## REQUIRED INFORMATION FOR TYPE 1 & TYPE 2 POOLS

Name:

Answer ALL questions.

If items are **NOT REMOVABLE** and **LESS THAN 18" FROM THE WATERLINE**, measurements must be given using the same method that was used to measure the pool. If your pool has obstructions and/or special features, please provide photos of each area.

### CHECK ONE:

YES NO

**1. Are there skimmer covers?**

Are the covers flush with the deck?

**2. Are there ladders?**

Are the ladders removable?

If No: Measure to locate ladders, and distance ladders extend into the pool.

**3. Are there handrails?**

Are the handrails removable?

If No: Measure to locate handrails, and distance handrails extend into the pool.

**4. Are there grab rails?**

Are the grab rails removable?

**If No:** Measure to locate grab rails, distance rails are set back from the pool, and to points where the rails dip below the coping. Also indicate type of grab rail.

**5. Is there a fill spout?**

Is the fill spout removable?

**If No:** Measure from pool to front of fill spout.

**6. Is there a dive stand?**

**If Yes:** Measurements are required.

How far back is the stand from the pool? \_\_\_\_\_

**7. Is there a slide?**

Are slide legs within 18" of the waterline?

**If Yes:** Measurements are required. Also give distance legs are set back from pool edge.

**8. Are there any Grab Rocks?**

**If Yes:** Measure to locate placement. How wide are the rocks? \_\_\_\_\_

**9. Is there a spa?**

Is the spa level with the deck and/or coping?

**If No:** How much is the spa raised above the pool? \_\_\_\_\_

**10. Is a separate cover required for the spa?**

### CHECK ONE:

YES NO

**11. Does the spa wall have an open spillway?**

If it is an open spillway, A-B dimensions are required to locate the spillway. (Please provide a photo.)

**12. Is there a planter area?**

**If Yes:** Give A-B dimensions at start and finish of planter area. Give width of coping between the pool and the front of the planter.

**13. Do you require stakes or anchors in the planter area?**

**14. Is the planter raised?**

**If Yes:** What type of material is the planter made of? \_\_\_\_\_

**15. Is the planter strong enough for the cover to snap-hook into?**

**16. Is there a raised wall or raised bond beam?**

**If Yes:** How high? Give A-B dimensions at the beginning of the wall as well as points along the wall at the deck line. \_\_\_\_\_

**17. Are there waterfalls or rocks?**

**If Yes:** Give A-B dimensions of the beginning and at the end of the obstruction as well as points along the pool. (Please provide a photo.)

**18. Are there varying deck levels?**

**If Yes:** Give A-B dimensions at level change. Give A-B dimensions indicating the angles where the level change cuts back from the pool.

How much of a level change is it? \_\_\_\_\_

**19. Do you have at least 3 feet of deck around the pool?**

**If No:** Please show dimensions on your sketch.

**20. Do you have a concrete deck?**

**If No:** Please specify what type (wood, brick, etc.). \_\_\_\_\_

### FOR REPLACEMENT OF EXISTING SAFETY COVERS ONLY

#### CHECK ONE:

YES NO

**1. Is this a replacement safety cover?**

**2. Do you need to match existing anchors?**

**3. Is the old cover available?**

**4. Do you know the manufacturer of your old cover?**

Manufacturer \_\_\_\_\_

Serial Number \_\_\_\_\_

**Important:** If the old cover is not available, please provide A-B measurements of the pool perimeter as well as the anchor locations.

## IMPORTANT!

Submitting this measuring form indicates that you have verified your measurements, and that the information you have supplied to us is correct. Your new safety cover will be made to these specifications when you place your order. If you need to make changes to your measurements and specifications, please resubmit them in writing. Custom Safety Covers are not returnable.

**GRAPH FOR TYPE 1 & TYPE 2 POOLS**

Name:

Please specify inside dimensions on this form.

*\* Please also send 2 pictures of your pool. One viewed from the deep end to the shallow and one from the shallow end to the deep end.*

**PLEASE USE BLACK INK AND ADDITIONAL PAGES IF NECESSARY**

