

# HOOPS DUAL ELECTRONIC BASKETBALL - NG2237BL

## Spec Sheet

UPC Code: 672875902958

40" x 22.5" backboard is 1/2" CARB certified MDF with 4-color graphic laminated front.

Ball Return is made of blue heavy duty nylon canvas with white graphics and double stitching to hold white side nets. Bottom return area is approx. 38" W x 84" L with a 7.5" H bottom catch lip and 36" H sides at tallest point.

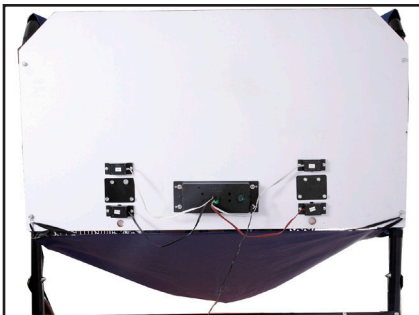

LED infrared dual display electronic scoring and timing clock -- 9" x 3.25". Motion sensors mounted above and below rim -- 3" x 1.25" each.



Frame is 1.25" dia. black powder coated heavy gauge steel tubing with built in hinge and locking system to allow folding for storage.









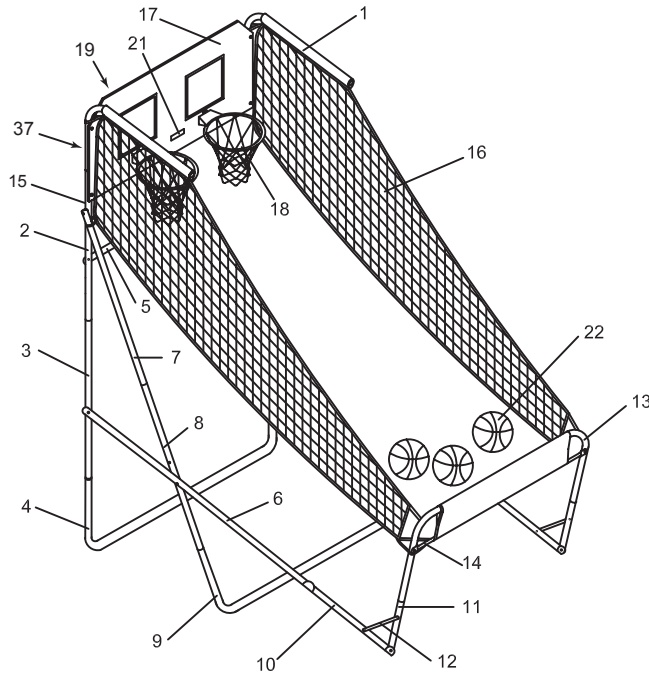



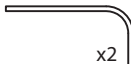

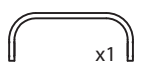

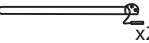







Includes six 7" dia. basketballs, ball pump with needle and two black nylon basketball nets.

# HOOPS DUAL ELECTRONIC BASKETBALL - NG2237BL













## Spec Sheet



### PARTS

#1 NGP5620 17.5" x 29.5" 1.25" Dia. Steel  x2 REAR TOP LEG	#2 NGP5621 28" 1.25" Dia. Steel  x2 REAR MIDDLE LEG	#3 NGP5622 18" 1.25" Dia. Steel  x2 REAR BOTTOM LEG	#4 NGP5623 40.5" x 19.75" 1.25" Dia. Steel  x1 REAR BASE	#5 NGP5624 40" 1/2" Dia. Steel  x1 REAR CROSS BASE	#6 NGP5625 34.75" 1.25" Dia. Steel  x2 BACK ARM	#7 NGP5626 28" 1.25" Dia. Steel  x2 CENTER TOP LEG
#8 NGP5627 18.5" 1.25" Dia. Steel  x2 CENTER MIDDLE LEG	#9 NGP5628 38.5" x 20" 1.25" Dia. Steel  x1 CENTER BASE	#10 NGP5629 40.5" 1.25" Dia. Steel  x2 MIDDLE ARM	#11 NGP5630 15" 1.25" Dia. Steel  x2 FRONT ARM	#12 NGP5631 16.5" x .5" 1/8" Steel  x2 HINGE	#13 NGP5632 40" x 20" 1.25" Dia. Steel  x1 LEAN BAR	#14 NGP5633 40" 1/2" Dia. Steel  x1 FRONT CROSS BRACE
#15 NGP5634 1" x .375" Steel  x2 RETAINING HOOK	#16 NGP5635B 38" x 84" x 36" Nylon Canvas  x1 BALL RETURN NET	#17 NGP5636B 17.5" x 29.5" 1/2" MDF  x1 BACKBOARD	#18 NGP5637 12" Dia. 1/2" Solid Steel & Nylon  x2 RIM WITH NET	#19 NGP5638 3" x 2.5" Steel  x2 SUPPORT PLATE	#21 NGP5639 ABS Scorer: 9" x 3.25" ABS Sensors: 3" x 1.25"  x1 ELECTRONIC SCOREBOARD	#22 NGP2217 7" Dia. Rubber  x6 BASKETBALL
#23 NGP5640 1.25" Dia. x 6" ABS  x1 PUMP WITH NEEDLE	#35 NGP5641 120VAC 60Hz 55mA  x1 AC/DC POWER SUPPLY	#37 NGP5643 6" x .75" x .5" Foam Rubber  x2 FOAM STRIPS				

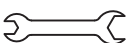
### HARDWARE PACK - NGP5642

#20 x2  60MM BOLT	#24 x14  35MM BOLT	#25 x4  20MMX5MM BOLT	#26 x8  20MMX6MM BOLT	#27 x4  45MM BOLT	#28 x2  40MM BOLT	#29 x8  3/4" SCREW
#30 x30  FLAT WASHER	#31 x30  LOCK NUT	#32 x4  LOCK NUT	#33 x1  WRENCH	#34 x1  HEX WRENCH	#36 x4  FLAT WASHER	