

ZIPLLEVEL[®] **PRO-2000**

High Precision Altimeter

TECHNIDEA
CORPORATION

CUSTOMER SERVICE:
1.800.805.LEVEL (5383)
V: 1.760.480.4740
F: 1.760.480.4738
www.zipllevel.com

USER
GUIDE

ZIPLEVEL SYSTEM CONCEPT

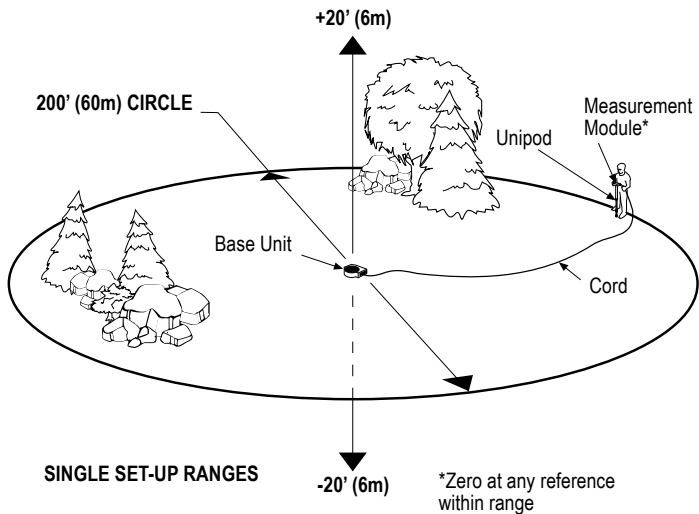

INTRODUCTION

You're about to enter an exciting new labor saving world of elevation measurement and leveling. The **ZIPLEVEL® PRO-2000** High Precision Altimeter lets you focus on your work rather than the tedious task of measuring your work. **ZIPLEVEL®** is the first instrument of its kind to let you truly work alone, set-up instantly and measure without line-of-sight, distance error, factory calibration or math.

Unlike conventional builder's and laser levels, **ZIPLEVEL®** displays vertical measurements directly in large, easy to read digits. Select one of six scales and cover up to 40' (12m) vertically with 0.050" (1mm) precision over a 200' (60m) circle on a single set-up – equivalent to owning five 40' (12m) rods and an imaginary 20' (6m) tripod. The High Precision function provides paper-thin precise vertical readings within 0.005" (0.1mm) over 4' (1.2m). A built-in Carry Function retains your original benchmark Zero over unlimited ranges without the differential leveling tabulation, tedious calculations and endless errors.

INTRODUCTION

Use any of **ZIPLEVEL**'s 16 powerful built-in functions to master tough elevation measuring and leveling tasks from estimating, planning, excavation, construction and landscaping to fabrication, checking and analysis. Attach the optional PC Serial Link to **ZIPLEVEL**'s built-in Serial Port and make **ZIPLEVEL**® a powerful data gathering instrument capable of downloading stored measurements to a Personal Computer for analysis and tabulation or plots of profiles, sections and topographical maps.

Carefully review this User Guide and with a little practice you'll soon cut time, cost and frustration from your work.

TABLE OF CONTENTS

LABELED FUNCTIONS	ZIPLEVEL ® Basics.....	1-6
	Quick Start	7
	On/Off, Hold & Zero.....	9
	Scale & Resolution.....	11
	Calibration.....	13
	Record	15
	Mark	17
HIDDEN FUNCTIONS	Temperature & High Precision.....	19
	Carry.....	21
	Record Data	23
	Inspect/Dump & Initialize	25
	Elevation	27
	Monitor.....	29
	Display Alarm Indicators	30
	Use Tips	31
	How to Measure Accurately.....	32
	ZIPLEVEL ® Care.....	34
	Troubleshooting	36
	Maintenance/Product Assistance.....	37
ZIPLEVEL ® Specifications	38	

1 • ZIPLEVEL BASICS

ZIPLEVEL® consists of a Base Unit (BU) and hand-held Measurement Module (MM) joined by a rugged wireless Cord that communicates elevation data from the BU to the MM. Stakes secure the Base Unit on unstable terrain. A Unipod eliminates constant bending for multiple readings and doubles as a vertical calibration standard when fully extended. All components are stored in the Base Unit when not in use. To use **ZIPLEVEL**:

- 1) Secure the Base Unit on its back at any convenient location and pull enough Cord from the reel to cover the area to be measured. If desired, attach the Unipod to the Measure Module. Although it is not necessary for the Base Unit to be level, it must be secure.
- 2) Momentarily press the ON/OFF key to turn on the **ZIPLEVEL®**.
- 3) Press the ZERO key for 2 seconds to set a level zero plane at any reference or benchmark within **ZIPLEVEL's** 200' (60m) horizontal, and +/- 20' (6m) vertical range.

Note: If the Base Unit moves, you must re-zero the Measurement Module at the benchmark before continuing.

ZIPLEVEL PARTS • 2

To remove the boot:

1. Place against chest
2. Pull back 1" with 4 fingernails each side.
3. Grip Measurement Module and Boot and pull Boot off.

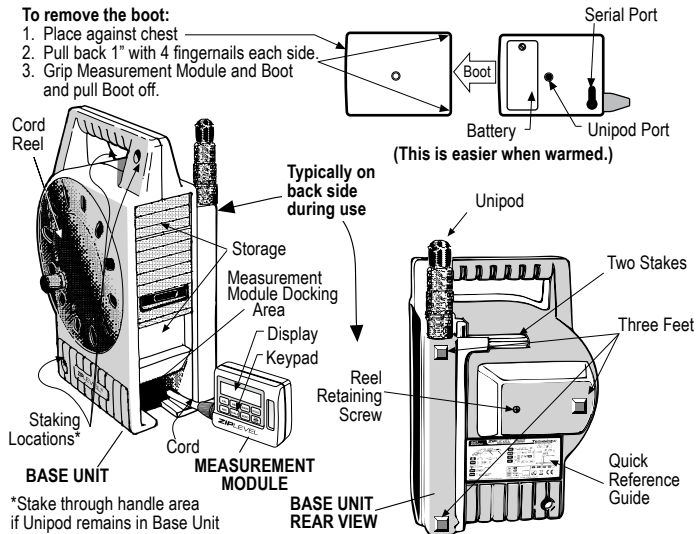

3 • MEASUREMENT MODULE

Use the Measurement Module to level and take readings. The bottom and back of the Module are the only sides that may be used interchangeably for measurements. You may use other sides only if you first zero on that side. Hold the Module level and measure near the center of the side in use. Do not zero the Module and then invert it without correcting the reading as shown in the illustration on the next page.

Example: To measure the distance between the floor and ceiling: First, zero the Measurement Module on its back or bottom on the floor. Then place its top, bottom, or back against the ceiling to take a reading. Finally, add the appropriate correction factor shown in the illustration.

MEASUREMENT MODULE • 4

Display reading is equivalent for measurements taken from back or bottom.

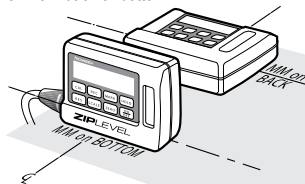

To avoid adding values, use the same side for start and finish, without rotating or inverting.

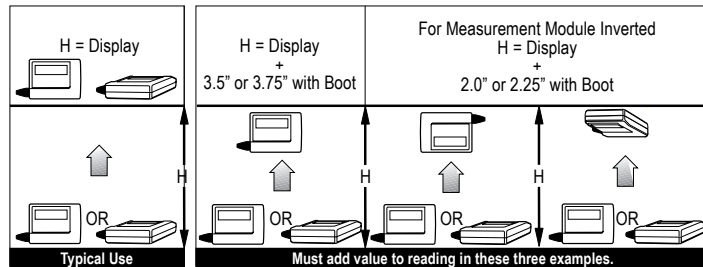
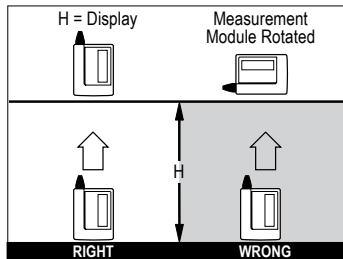

5 • KEYPAD

Use the keypad on the Measurement Module to control the **ZIPLEVEL®** and take readings. The most frequently used functions, called labeled functions, are printed on the eight keys below the display.

ZIPLEVEL®'s more advanced or less frequently used functions, called hidden functions, may be accessed by logical combinations of two or more keys. All keys except the HOLD and ON/OFF keys must be pressed and held for two seconds to activate. This minimizes accidental operation of the functions.

Distinctive audible and display indicators ease use – you will soon learn to recognize them. For example, when a measurement is nearly stable enough to read, you will hear two short 'read ready' beeps. When storing a reading, **ZIPLEVEL®** emits short, regular beeps while the display flashes. When the reading is stable enough to store, the unit then emits a single long tone.

Note: All stored measurements and settings are retained indefinitely once power is shut off and even without a battery installed.

KEYPAD & DISPLAY • 6

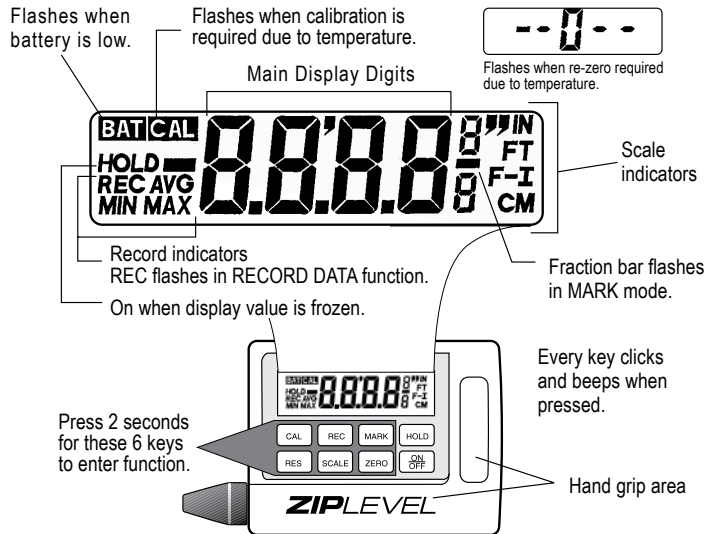

Most **ZIPLEVEL**® users will use only those functions routinely necessary in their work. We suggest that you try all **ZIPLEVEL**® functions at least once to become familiar with its capabilities. This Quick Start will help you gain confidence by using a few frequently used functions:

1. Raise the lower door of the Base Unit, remove the Measurement Module and lay the Base Unit on its back on the floor or ground. The Base Unit should be secure but need not be level.
2. Pull enough Cord from the reel to cover the area to be measured and momentarily press the ON/OFF key to turn the unit on.
3. Place the Measurement Module on a nearby surface and press the ZERO key for 2 seconds and hold steady until zeroed. You have now created an imaginary infinite size level reference plane.
4. Move the Measurement Module to a different elevation. It will display the difference in elevation with negative readings below and positive above the reference plane.
5. Momentarily press ON/OFF key to shut off unit. Reel in the entire Cord letting twists near MM spin out, put Module in its docking area and lock door.

WARNING: READ & UNDERSTAND ENTIRE USER'S GUIDE BEFORE USE.

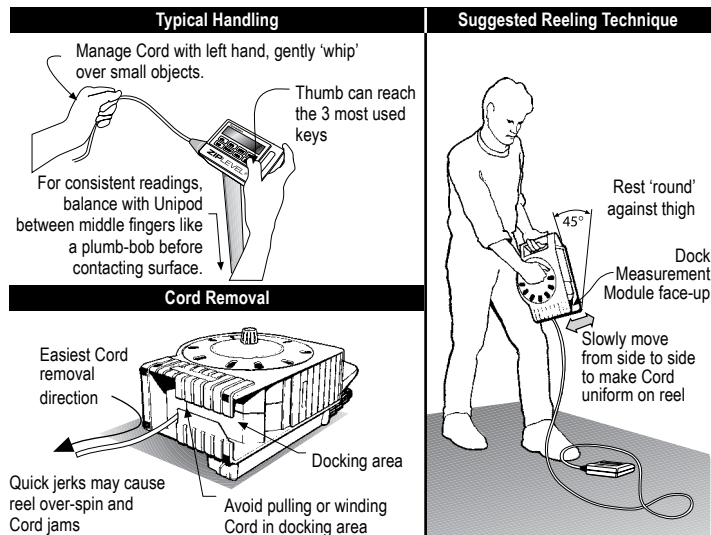

9 • LABELED FUNCTIONS

This section describes how to operate **ZIPLEVEL**'s labeled functions. Glance through all the functions and illustrations then try each function on the **ZIPLEVEL**®.

ON/OFF

Momentarily press to turn **ZIPLEVEL**® on or off. Without a key press or movement within 3 minutes, two long warning beeps will sound followed by automatic turn off at 4 minutes. All settings and data are retained.

HOLD

Momentarily press to freeze an elevation on the display. Press again to release. Use when the display is not visible, when measuring ceiling sag with the Unipod, in dimly lit areas, etc.

ZERO

Press for 2 seconds to make the current elevation a reference or benchmark plane. Re-zero at new elevations like large level steps, pool bottoms or block courses to let **ZIPLEVEL**® do the high/low math.

HOLD & ZERO • 10

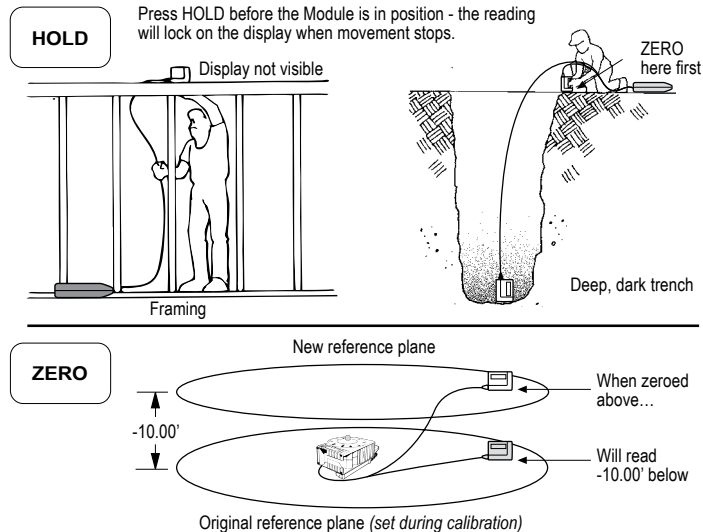

SCALE

Press for 2 seconds and continue to press or press and release to select fractional inches (") , decimal inches (IN), engineer's feet (FT), builder's feet-inches (FT-IN), centimeters (CM) or meters (M). Fractional scales and meters are not available in the High Precision function (Pages 19 & 20). If you HOLD a reading on the display then SCALE can be used as a scale converter.

RES

Press 2 seconds to enter and continue to press or press and release to select the desired measurement RESolution (measurement precision). Lower resolution (larger values or increments) provides faster readings for rough grade or estimates.

SCALE

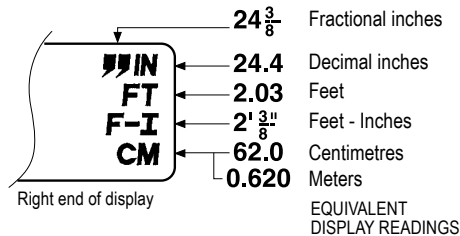

RES

TYPICAL DISPLAY

(Decimal Inches Scale)

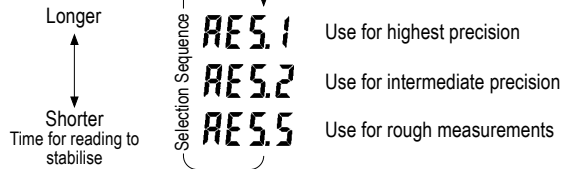

Unlike rotary lasers and optical levels, the **ZIPLEVEL®** is not tilt sensitive, its level plane does not develop tilt error and it does not amplify error with distance or require factory calibration. The CAL function lets you calibrate vertical measurement accuracy much like calibrating the vertical sight rod of a rotary laser. Calibration may be needed for accurate vertical measurements but is not required for leveling operations.

Always check calibration before doing accurate vertical measurements, particularly if the temperature has changed 36°F (20°C) or more since the last calibration causing CAL to flash on the display or if you have never calibrated a new or newly serviced **ZIPLEVEL®**. You can easily check calibration in two steps: 1) Zero the Measurement Module on bottom or back on a flat surface beside the Base Unit. 2) Raise the Measurement Module 4' (121.9 cm) above the zero point (still on bottom or back) to be sure the display closely matches the height raised. The fully extended and calibrated Unipod, a sheet of plywood or a tape rule can be used as a calibration standard. If calibration is necessary then follow the easy 3 steps in the illustration. You can exit from calibration at any time by pressing the CAL key for two seconds.

CAL

To extend, loosen/tighten bushings top down (1, 2, 3)

1 Adjustable and reversible foot

2 Unipod

3 Rubber tip

Jam nut

To collapse, loosen/tighten from bottom up (3, 2, 1)

Occasionally check Unipod for 4' with a tape rule.

Step 1 Press CAL 2 seconds to start 3 beep tone.

Step 2 Lay bottom or back down close to Base Unit and press CAL again
[] ←→ 0 display*
Then [48] or [121.9] flashes and 2 beep tone

Step 3 Raise to 48" (121.9cm), press CAL again and hold steady
[] ←→ 48" or 121.9cm display*
Then normal display resumes as 48" or 121.9cm
*a single beep sounds until value is locked in.

To adjust length, loosen jam nut, turn foot in or out and re-tighten nut. To reverse foot for pointed end, remove foot and rubber tip, place jam nut in opposite end of foot, reassemble foot, blunt end first, back into Unipod, adjust and tighten jam nut.

Step 2

Step 3

48.00" (121.9cm)

Same spot

The RECord function eliminates extensive tabulation and computation required to average large numbers of readings. Now you can easily estimate the slurry necessary to level an uneven concrete surface, the fill needed below concrete or predict the graded level of a hilly lot (see illustrations). You can also estimate the volume of a pile of dirt or the volume to fill a hole by first finding the difference between the average of readings every pace around the edge of the pile or hole and the average of readings at every pace criss-crossing the pile or hole. Volume = (difference of the two averages) X (estimated cross-sectional area of the pile or hole).

To enter the record function, press REC 2 seconds causing REC to appear on the display. Momentarily press REC to display current reading, AVG (average), MIN (minimum) or MAX (maximum). Press HOLD momentarily to include each of an unlimited number of readings in the computations.

Press REC 2 seconds to exit the Record function. Previously computed data will be replaced with new data if you press the HOLD button after re-entry.

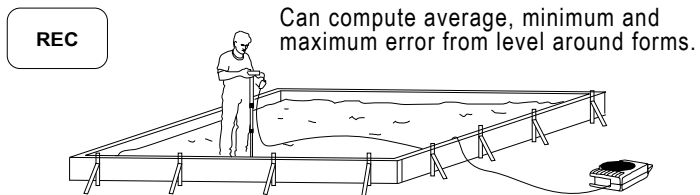

Calculates fill needed below concrete.

ZERO at bottom level for concrete, take as many measurements as needed.
Volume = Average x Area

Predicting lot elevations

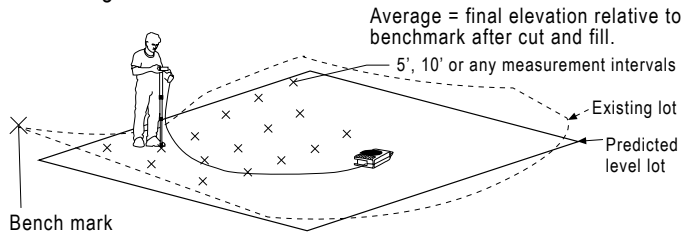

The MARK function lets you create audible tones: 1) at a selected elevation, 2) for elevations within a selected band, or 3) elevations outside a selected band. Tones may be set over **ZIPLEVEL**'s full vertical single setup range.

To set tones, place the Measurement Module at the desired elevation, press MARK 2 seconds and hold steady until double band lines flash on the display then press MARK momentarily: 1) without moving the Module for a tone at the elevation or 2) after moving the Module below for a tone within the band or 3) after moving the Module above for a tone above the band, beeps below and silence within. The fraction bar to the right flashes while in the Mark function.

Press the MARK key 2 seconds to exit – settings will be lost. To exit and retain settings, momentary press ON/OFF while pressing MARK. Press MARK 2 seconds to re-enter.

MARK

Tones can supplement display to level or alarm at height limits.

STEP 1	Enter at elevation	STEP 2	Set band
DISPLAY			
TONES	Double beep	Single beep	
ZONE AT MARK			
ZONE INSIDE OF BAND			
ZONE OUTSIDE OF BAND			

TEMPERATURE

To display ambient temperature, continue to press ON/OFF for 2 seconds when turning ON. Momentarily press any other key to exit temperature.

HIGH PRECISION

The High Precision function lets you measure with an unprecedented paper thin 0.005" (0.1mm) internal precision over a vertical range of 4' (1.2m). With this revolutionary capability you can detect minute surface errors, set precise pool negative edges, precisely fixture shop fabrications or set plant equipment and do real time beam deflection measurements. The possibilities are endless.

To enter or exit, momentarily press ON/OFF while pressing the RES key. You must re-zero when changing in or out of High Precision. When in High Precision, HP will appear with readings in decimal inches, feet and centimeters. For a lower precision, press the RES key for at least 2 seconds and release at the desired precision. Vertical calibration (CAL) is still done at 4' (121.9cm). With the highly precise HP measurements it is particularly important to comply with the How to Measure Accurately Guidelines on Page 32. Avoid interchanging Module bottom and back in the HP function.

HIGH PRECISION

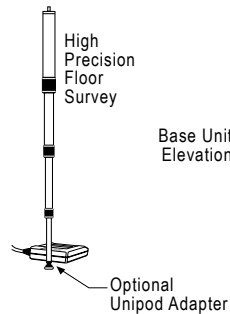
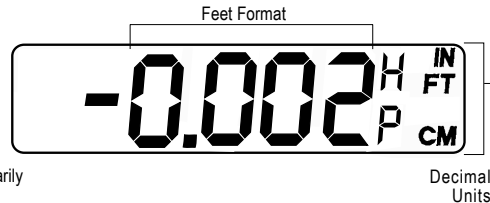

HIGH PRECISION RANGES

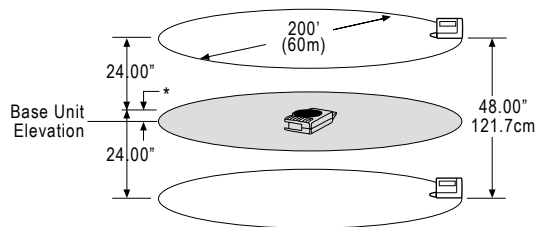

*Base Unit May Be Offset +/- 5.0" (13cm) From Vertical Range Limits.

The CARRY function lets you leap-frog the Measurement Module and Base Unit to measure elevations (differential level) over any distance or elevation on earth without tabulation, computations or loss of your original benchmark plane. Two people working together can traverse terrain at a 2 mph (3 kph) rate.

To use the CARRY function follow the steps in the illustration. Repeat the HOLD and ZERO sequence over any distance or elevation. You may keep the Base Unit vertical for ease of leap-frogging if it was vertical when setting the benchmark.

To exit CARRY within any set-up, press and hold the ZERO key for two seconds without the HOLD indicator showing. You can then do a new set-up zero without loss of the CARRY benchmark and later re-enter CARRY by pressing HOLD and then ZERO for 2 seconds without moving the Module.

CARRY

Can measure the height of a mountain or locate an elevation across town – no pencil, paper or calculator needed.

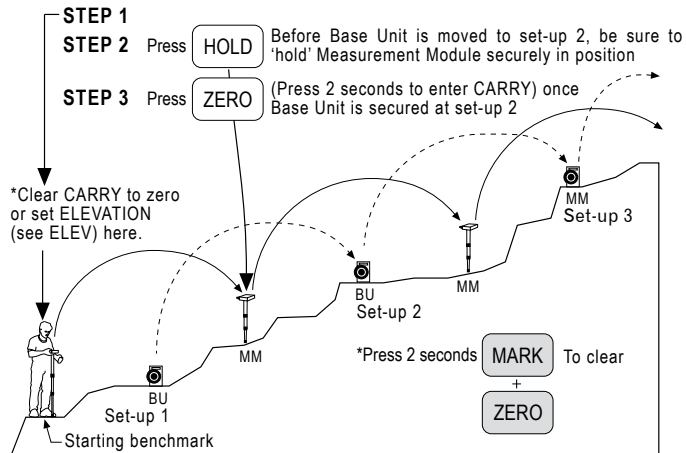

ZIPLEVEL® can be used to record measurement data for creating tables, profiles, sections, contour or 3D maps. Press REC and MARK together for 2 seconds to enter or exit. REC will be flashing on the display while in the Record Data function. Press REC and ZERO together for 2 seconds to clear all data. Press HOLD momentarily to record each measurement. Press the ZERO key for 2 seconds to back step and clear a previous measurement, then momentarily press and release to clear additional measurements.

With each measurement, the display shows that measurement's position within a sequence (PXXX) and the sequence number (fraction digits). Press MARK 2 seconds to start a new sequence. The display will flash 'FULL' with each measurement when memory is within 20 measurements of being filled. The number of remaining measurements will show in the fraction digits. A PC can be connected to the serial port to store, graph or tabulate each measurement as it is taken for an unlimited number of measurements. The position display will show (FXXX) after the **ZIPLEVEL®** memory is full.

The REC DATA function can be used while in the CARRY function to record data with each press of the HOLD key. CARRY data and normal data won't mix – storing one will delete all other data.

**REC
DATA**

Saves up to 137 measurements, or an unlimited number with a PC. Take measurements over a grid of regular surface intervals for a contour or 3D map. One sequence can define a profile or section.

Press **HOLD** momentarily to record Press **ZERO** 2 seconds, back space (erase)

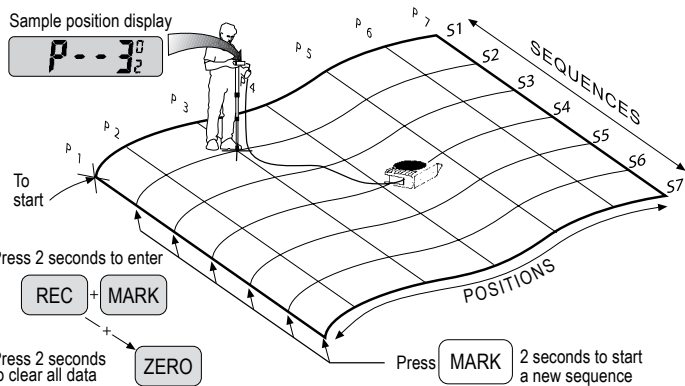

INSPECT or DUMP

These functions allow inspection of Record Data registers and/or data transfer to a PC. To use this function: Press and hold CAL and REC keys together for two seconds to INSPECT data. Momentarily press the MARK key to sequence up through positions. Momentarily press the REC key to sequence down through positions. To sequence up or down in multiples of ten positions, momentarily press the HOLD key for up and CAL key for down. Momentarily press the CAL and REC keys together to DUMP data to a PC.

INITIALIZE

This function resets all user settings to default values providing an easy way to escape from an unwanted function. It will be necessary to re-calibrate after you initialize. Place the Measurement Module back down on a flat surface and press the entire top row of keys for two seconds with two fingers from each hand.

INSPECT
/DUMP

Press CAL and REC two seconds to enter or exit INSPECT
Press CAL and REC momentarily and release to DUMP data to PC

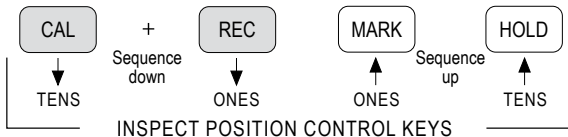

Compact PC mounted to Unipod in left hand or in pocket with display visible to operator

RECORDING DATA 'ON THE FLY'

When ZIPLEVEL registers fill, 'FULL' will display but record data to PC can continue indefinitely.

Elevation lets you preset the display and Carry reference plane to a benchmark elevation in engineers (FT) or metric scales for use in the CARRY function. You may preset the ELEV function to zero by pressing MARK and ZERO together for 2 seconds before entering the ELEV function. To enter or exit the ELEV function, press and hold the SCALE and RES keys together for 2 seconds.

It's best to set digits starting with the least significant—momentarily press the HOLD key to set the hundredths digit, press the MARK key to set tenths, the REC key for ones, the CAL key for tens, the SCALE key for hundreds and the RES key for thousands. Press the ZERO key to select up or down.

To use your preset elevation, exit ELEVATION and enter CARRY (see page 21).

ELEV

Allows preset of elevation in CARRY function.
First place measurement module at benchmark.

Press two seconds **RES** + **SCALE** to enter or exit

Display looks similar to CARRY function:

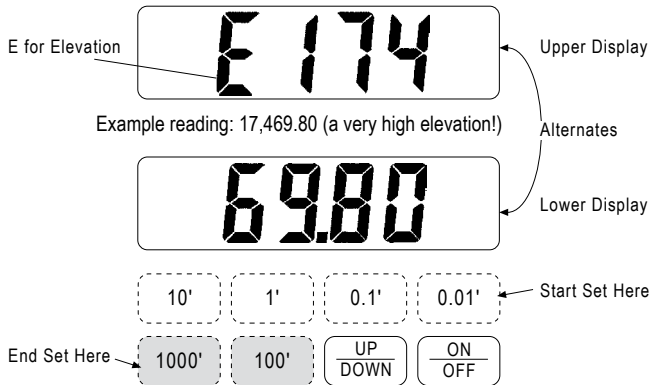

The Monitor function can be used to keep the **ZIPLEVEL**® from shutting off during periods of inactivity. It also can be used with the optional PC Serial Link for remote monitoring or data logging. For example, place the Base Unit on a Styrofoam® float to log water tank or river levels.

To enter the MONITOR function, press and hold the ON/OFF and CAL keys together for two seconds when turning on **ZIPLEVEL**®. To exit, turn the unit off. The MONITOR function disables the AUTO-OFF feature and enables continuous data from the Serial Port.

CAUTION: MONITOR reduces battery life by at least 40%. Remember to shut off when finished to avoid loss of battery.

- CAL Flashes if unit needs to be re-calibrated due to a 36F (20C) temperature change since last calibration. CAL is on constantly when unit is outside of the -22°F to +158°F (-30C to +70C) operating temperature range. CAUTION: Vertical measurements may be in error.
- 0-- Periodic flash on the display indicates re-zero may be necessary due to a temperature change of 18F (10C) since the last zero.
- 8888 Alternates with displayed elevation when the Measurement Module is more than 20' (6m) above or below the Base Unit. CAUTION: Overrange measurements may be in error. If 8888 flashes well within range, check troubleshooting chart; check for Cord damage or leakage and if necessary, return for service.
- BAT Flashes when only a few hours of battery life remain. A fresh 9V alkaline battery can allow up to 60 hours of active use.
- CORD Flashes to indicate need for routine factory Cord recharge required about every 3 years or possible Cord damage. CAUTION: Measurements may be in error.

*See page 6 for illustration of alarm indicators.

- 1) Secure the Base Unit after removing the Measurement Module.
- 2) Extend the Unipod from the top down and retract from the bottom up (see page 14). Always gently tighten bushings (avoid over-tightening).
- 3) Hold the Measurement Module in the handgrip areas to the right and beneath the keypad. For single handed operation, use the thumb to press the most frequently used buttons: ON/OFF, HOLD and ZERO. The left hand can manipulate the Cord. Release or hold steady while reading (see page 8).
- 4) In muddy conditions use a rag to wipe down the Cord before reeling in. This can also remove Cord twists.
- 5) Place Module on ground beside Base Unit then pick up Base Unit and reel Cord through Cord entry area by holding the Base Unit handle with Base Unit tilted backward at about 45° (for example, resting against thigh). This will ease reeling, reduce wear and keep docking area clean (see page 8).
- 6) Use a coin, screwdriver or thumbnail to loosen battery door screw to replace 9V alkaline battery. Lift the terminal end of battery with thumbnail or simply thump Measurement Module against your hand and catch the battery. Note: The protective Boot is more easily removed when warmed.

ZIPLEVEL® isothermal readings are typically precise to within 0.2% of measurements 10' (6m) or less and 0.35% of measurements beyond 10' (6m). It can typically level to within 0.1" (2mm) or 0.01" (0.2mm) in High Precision over a single set-up.

- 1) For critical levelling frequently re-check or re-zero at the benchmark (CAL is not necessary for leveling). When possible minimize height differences between Cord, Base Unit and Measurement Module.
- 2) For critical elevation measurements, frequently re-check calibration and benchmark zero. Whenever possible avoid temperature differences between the Cord and Measurement Module (eg. sun vs. shade).
- 3) When moving the **ZIPLEVEL**® from one temperature to a much different temperature, such as from indoors to outdoors on a cold day, pull out as much Cord as needed and allow 10-15 minutes for **ZIPLEVEL**® to adapt to the change.
- 4) Avoid violent tugging, whipping or stomping on the cord without re-check or re-zero at the benchmark.
- 5) Promptly zero or calibrate **ZIPLEVEL**® when its display flashes -0- or CAL.

- 6) Always secure the Base Unit to prevent movement during measurements – it does not need to be level.
- 7) Avoid using **ZIPLEVEL**® beyond the specified ranges of elevation or temperature. The display will flash 8888 when beyond the +/-20' (6m) vertical range and the CAL will be on steady for temperatures below -22°F (-30C) or above +158°F (+70C).
- 8) Occasionally check the 4' (121.9cm) length of the fully extended Unipod for changes in length caused by wear. Adjust its length if necessary.
- 9) As with conventional instruments, additional errors may be caused during use outdoors on sunny or windy days. In such conditions pull out only as much Cord as is needed and avoid unnecessary loops over objects. Measurements are less affected by sun/shade in early morning, late afternoon, when overcast, in full shade or indoors. If a measurement varies when breezy, take the average reading.

ZIPLEVEL® is rugged, durable and designed to provide years of reliable performance when properly used. Here are some guidelines:

- 1) Avoid excessive strain on the Measurement Module by guiding the Cord with the left hand during use (see page 8).
- 2) Whenever possible use the protective boot on the Measurement Module. Avoid dropping the Measurement Module and never use as a hammer.
- 3) Do not immerse the Measurement Module in water or any other liquid or gas and avoid contact with solvents.
- 4) Minimize **ZIPLEVEL**® wear by wiping with a damp cloth (avoid scratching display window) or rinsing lightly to remove mud and dirt from the Base Unit, Cord and Measurement Module. In extreme cases the single screw at the back of the reel can be removed to release the reel from the housing for a thorough hosing.
- 5) Keep the Cord, Measurement Module or Base Unit out of the path of vehicle traffic and out of contact with hot objects such as smoldering cigarette butts, fresh asphalt or welding.

- 6) Pack up the **ZIPLEVEL**® when not in use for extended periods of time. Never leave out in foul weather or overnight. Avoid storage inside a hot closed vehicle or trunk.
- 7) **ZIPLEVEL**® contains a non-toxic biodegradable clear liquid. In the unlikely event that a damaged unit releases liquid or if the Cord is cut, bend over Cord and wrap with tape or wire to stop liquid release. Wipe up liquid with absorbent towels, remove residue with soap and water and return to factory for service.

Problem	Action
Unit won't turn on or shuts off soon after turn on	Replace battery
Display shows 8888 with steady tone even though elevation is small	Check for Cord kink or damage. Initialize (see page 25)
Unit is stuck in an undesired function and you can't remember how to escape	Initialize and don't forget to re-calibrate
Cord flashes on display and/or readings are not repeatable	Check Cord and Base Unit and return to factory for 3 year interval recharge and/or repair if damaged
ErrX flashes on display when unit is switch on	Return to factory – unit may need service

See page 30 for alarm indicators

Technidea Corporation warrants the **ZIPLEVEL® PRO-2000** High Precision Altimeter against deficiencies in materials and workmanship for one year from the date of purchase. The **ZIPLEVEL®** hydro-pneumatics are covered by a second year pro-rata warranty.

ZIPLEVEL® never requires factory calibration and normal use should allow years of use without repair. Every 2 - 3 years **ZIPLEVEL®** will flash "CORD" on the display indicating a need for a factory recharge of its hydro-pneumatics. For detailed warranty information, the location of your nearest service center and shipping information, visit www.ziplevel.com/service.

PRODUCT ASSISTANCE

If you have difficulty using your new **ZIPLEVEL®** after reading this User Guide then please email info@ziplevel.com or call 1.800.805.LEVEL(5383) or 1.760.480.4740 outside the USA.

MADE IN THE USA

Set-up vertical range:	40' (12m) (20' (6m) above and below Base Unit) 48"(122cm) full range in High Precision (HP)
Set-up horizontal range:	200' (60m) dia. Circle, (150' (46m) PRO-2000B)
Carry function range:	No limit
Range of zero or mark:	Full vertical range
Reading repeatability:	0.1" (2mm) or 0.01" (0.2mm) HP typical
Leveling accuracy:	0.1" (2mm) or 0.01" (0.2mm) HP typical
Elevation accuracy:	Greater of 0.1" (2mm)/0.01" (0.2mm) HP or 0.2% reading <10' (3m) & 0.35% reading >10' typ.
Record capacity:	16,384 with no practical limits
Record data capacity:	137 readings
Settings/data retention:	Indefinitely, even without battery
Operating temp. range:	-22°F to +158°F (-30C to +70C)
Storage temp. range:	-40°F to +158°F (-40C to +70C)
Shock resistance:	Measurement Module – 5' (2m) drop on concrete Base Unit – 3' (1m) drop on concrete
Water resistance:	Rain tight; not immersible
9V alkaline battery life:	60 hours active use (auto shut-off after 4 minutes inactive)

U.S. Patents: 4,878,297; 5,517,869; 5,726,365; 5,844,150