

HANGING CHAISE LOUNGE CHAIR ASSEMBLY INSTRUCTIONS



Please Do Not Hesitate to
Contact Our Consumer Hotline
at 800-759-0977
with Any Questions That May
Arise During Assembly or
Use of This Product!

THANK YOU!

Thank you for purchasing this product. We work around the clock and around the globe to ensure that our products maintain the highest possible quality. However, in the rare case of issues during assembly or use of this product, please contact our Consumer Hotline at **800-759-0977** for immediate assistance before contacting your retailer. Please read the warranty information at the back of these assembly instructions for further details.

ASSEMBLY TIPS

IMPORTANT! PLEASE READ THESE ASSEMBLY INSTRUCTIONS IN ENTIRETY BEFORE ASSEMBLING YOUR PRODUCT.

1. Find a clean, level surface to begin the assembly of your chair. We recommend that two adults work together to assemble this chair. You may want to carefully cut or tear the four corners of the box so that the bottom of the box can be used as your work surface.
2. Remove all of the contents from box and verify that you have all of the parts shown on the Parts List before you begin assembly. **Note: Some parts may be pre-installed or pre-assembled.**
3. Some figures or drawings may not look exactly like product.
4. ***When installing parts that have more than one screw or bolt, hand tighten all screws or bolts in place before final tightening with screwdriver or wrench.***
5. Electric screwdrivers may be helpful during assembly; however, please set a **low torque** and use extreme caution because screws may be stripped or overtightened, resulting in damaged parts, if the electric screwdriver's torque is set too high.

WARNINGS!

READ AND FOLLOW ALL ASSEMBLY, OPERATION AND SAFETY INSTRUCTIONS CAREFULLY.

CHOKER HAZARD - THIS ITEM MAY CONTAIN SMALL BALLS AND PARTS NOT SUITABLE FOR CHILDREN UNDER 3 YEARS OF AGE.

CARE AND USE







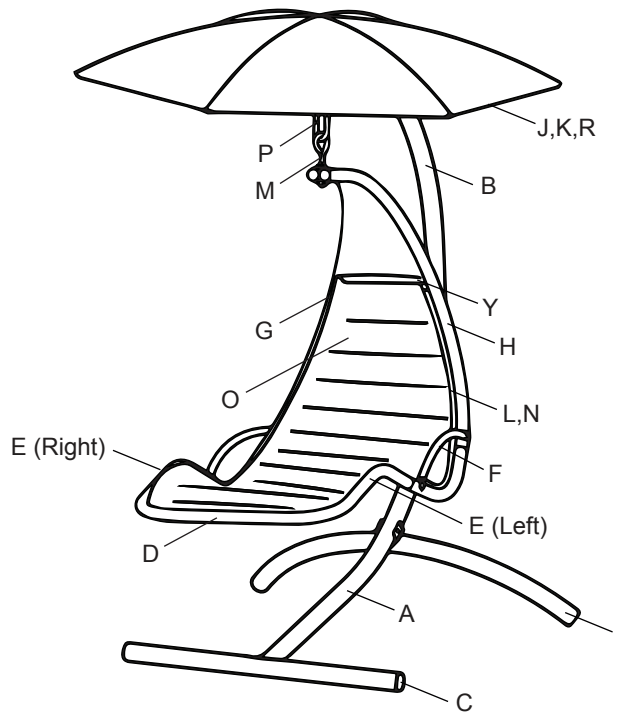



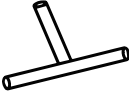
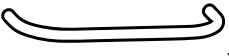
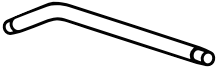

1. Can be cleaned with damp rag using mild soap and water.
2. Do **NOT** drag the chair when moving it, as this will damage the legs.

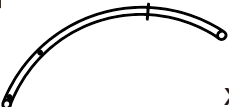
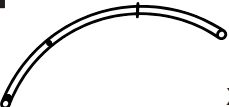
HANGING LOUNGE CHAIR - NU3215, NU3220 & NU3221

Parts List

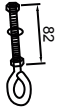









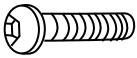

Illustrations Not to Scale

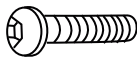
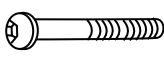
<p>A NUP2020</p>  <p>x1</p> <p>Bottom Pole</p>	<p>B NUP2021</p>  <p>x1</p> <p>Top Pole</p>	<p>C NUP2022</p>  <p>x1</p> <p>Front Base</p>	<p>D NUP2023</p>  <p>x1</p> <p>Front Seat Frame Pole</p>
<p>E NUP2024L - Left NUP2024R - Right</p>  <p>x2</p> <p>Seat Frame Connector Pole</p>	<p>F NUP2025</p>  <p>x2</p> <p>Seat Frame Brace</p>	<p>G NUP2026</p>  <p>x1</p> <p>Right Seat Frame Pole</p>	<p>H NUP2027</p>  <p>x1</p> <p>Left Seat Frame Pole</p>
<p>I NUP2028</p>  <p>x1</p> <p>Back Base</p>	<p>J NUP2029</p>  <p>x6</p> <p>Umbrella Rib</p>	<p>K NUP2030 - Beige NUP2039 - Terra Cotta NUP2040 - Khaki</p>  <p>x1</p> <p>Umbrella Canopy</p>	<p>L NUP2031</p>  <p>x1</p> <p>Seat Web</p>
<p>M NUP2032</p>  <p>x2</p> <p>Eye Bolt with Washer & Nut</p>	<p>N NUP2033</p>  <p>x1</p> <p>Seat Cord</p>	<p>O NUP2034 - Beige NUP2041 - Terra Cotta NUP2042 - Khaki</p>  <p>x1</p> <p>Seat Cushion</p>	<p>P NUP2035</p>  <p>x1</p> <p>Connection Link</p>

*Items included in Hardware Pack, NUP2038

HANGING LOUNGE CHAIR - NU3215, NU3220 & NU3221 Parts List (Cont.)

Illustrations Not to Scale

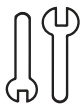
<p>Q NUP2038*</p>  <p style="text-align: right;">x1</p> <hr style="border-top: 1px dashed black;"/> <p style="text-align: center;">Bolt - M8x80mm</p>	<p>R NUP2036</p>  <p style="text-align: right;">x1</p> <hr style="border-top: 1px dashed black;"/> <p style="text-align: center;">Umbrella Mount</p>	<p>S NUP2038*</p>  <p style="text-align: right;">x4</p> <hr style="border-top: 1px dashed black;"/> <p style="text-align: center;">Bolt - M8x75mm</p>	<p>T NUP2038*</p>  <p style="text-align: right;">x4</p> <hr style="border-top: 1px dashed black;"/> <p style="text-align: center;">Bolt - M8x68mm</p>
<p>U NUP2038*</p>  <p style="text-align: right;">x11</p> <hr style="border-top: 1px dashed black;"/> <p style="text-align: center;">Washer</p>	<p>V NUP2038*</p>  <p style="text-align: right;">x9</p> <hr style="border-top: 1px dashed black;"/> <p style="text-align: center;">Nut</p>	<p>W NUP2038*</p>  <p style="text-align: right;">x2</p>  <p style="text-align: right;">x9</p> <hr style="border-top: 1px dashed black;"/> <p style="text-align: center;">Nut Cap</p>	<p>X NUP2038*</p>  <p style="text-align: right;">x2</p> <hr style="border-top: 1px dashed black;"/> <p style="text-align: center;">Bolt - M8x20mm</p>
<p>Y NUP2037</p>  <p style="text-align: right;">x1</p> <hr style="border-top: 1px dashed black;"/> <p style="text-align: center;">Cross Brace</p>	<p>AA NUP2038*</p>  <p style="text-align: right;">x1</p> <hr style="border-top: 1px dashed black;"/> <p style="text-align: center;">Allen Wrench</p>	<p>BB NUP2038*</p>  <p style="text-align: right;">x2</p> <hr style="border-top: 1px dashed black;"/> <p style="text-align: center;">Wrench</p>	

*Items included in Hardware Pack, NUP2038

ASSEMBLY INSTRUCTIONS

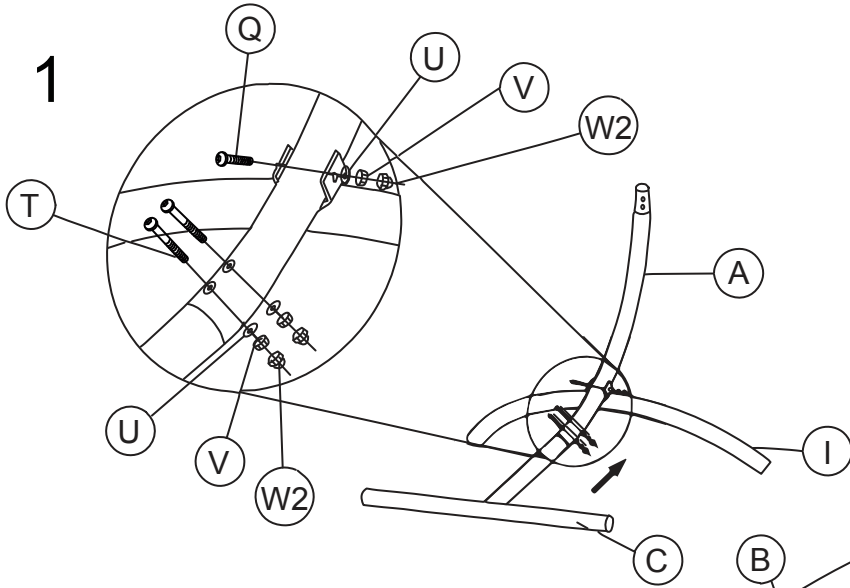

NOTE: Hand tighten all bolts in place, then tightening with wrench once fully assembled.

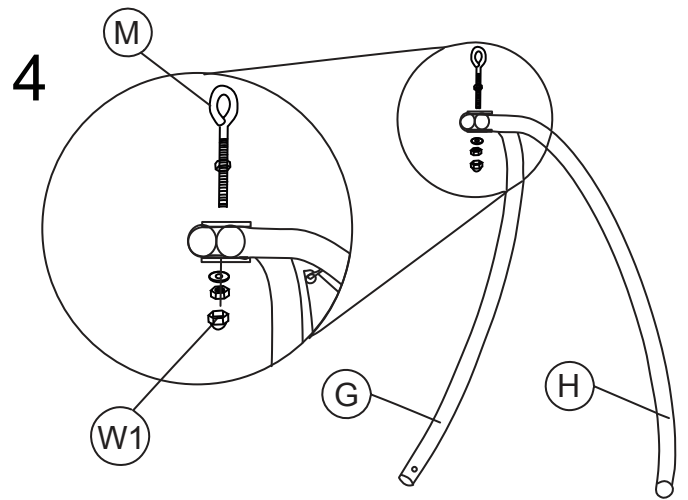
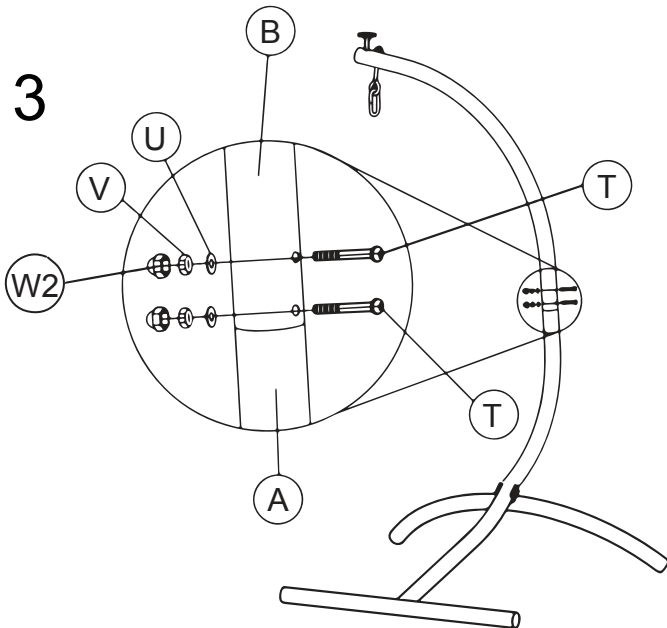
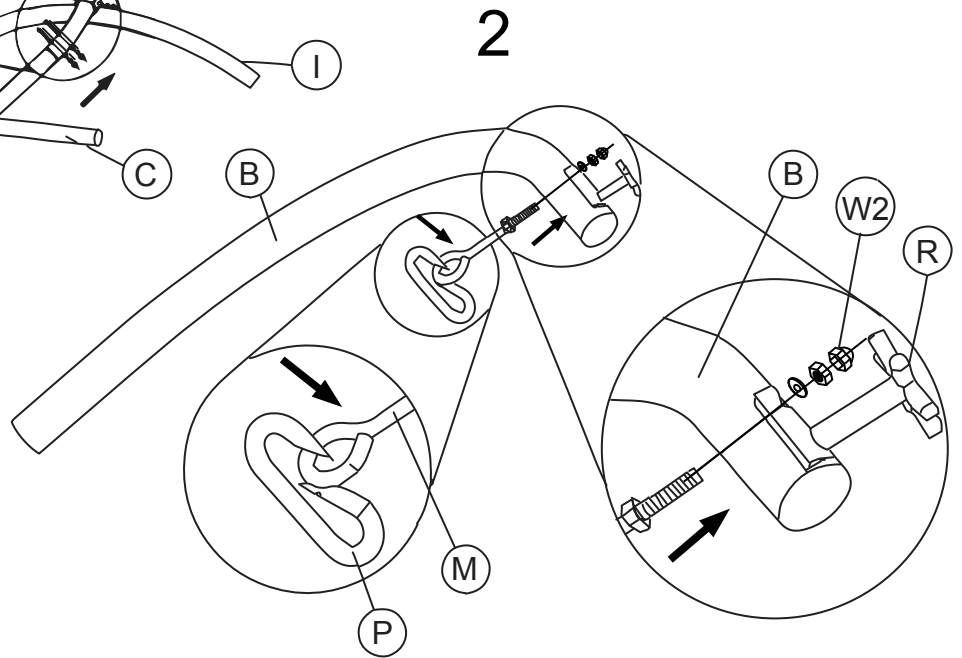

ASSEMBLY INSTRUCTIONS (CONT.)

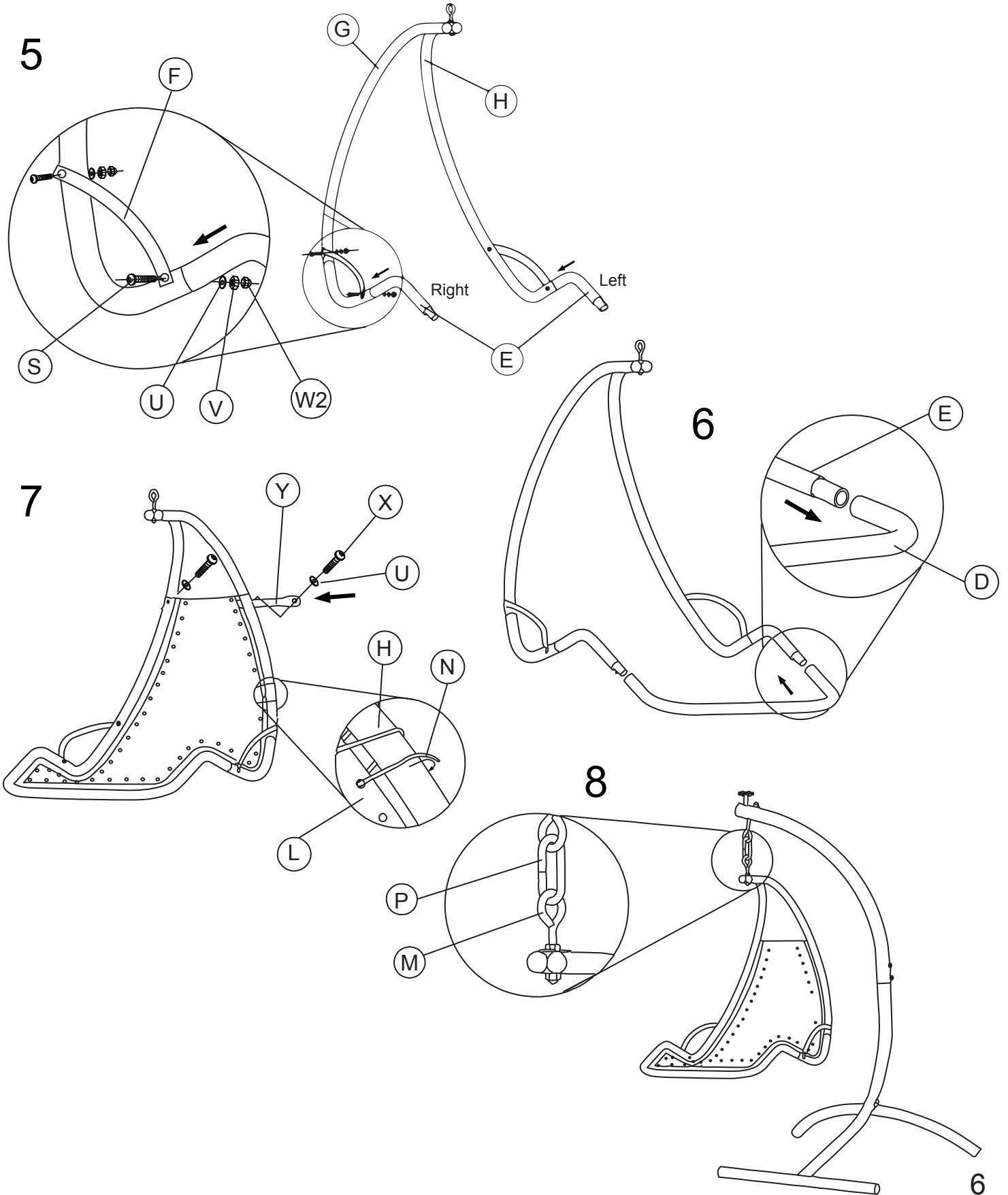

ASSEMBLY INSTRUCTIONS (CONT.)

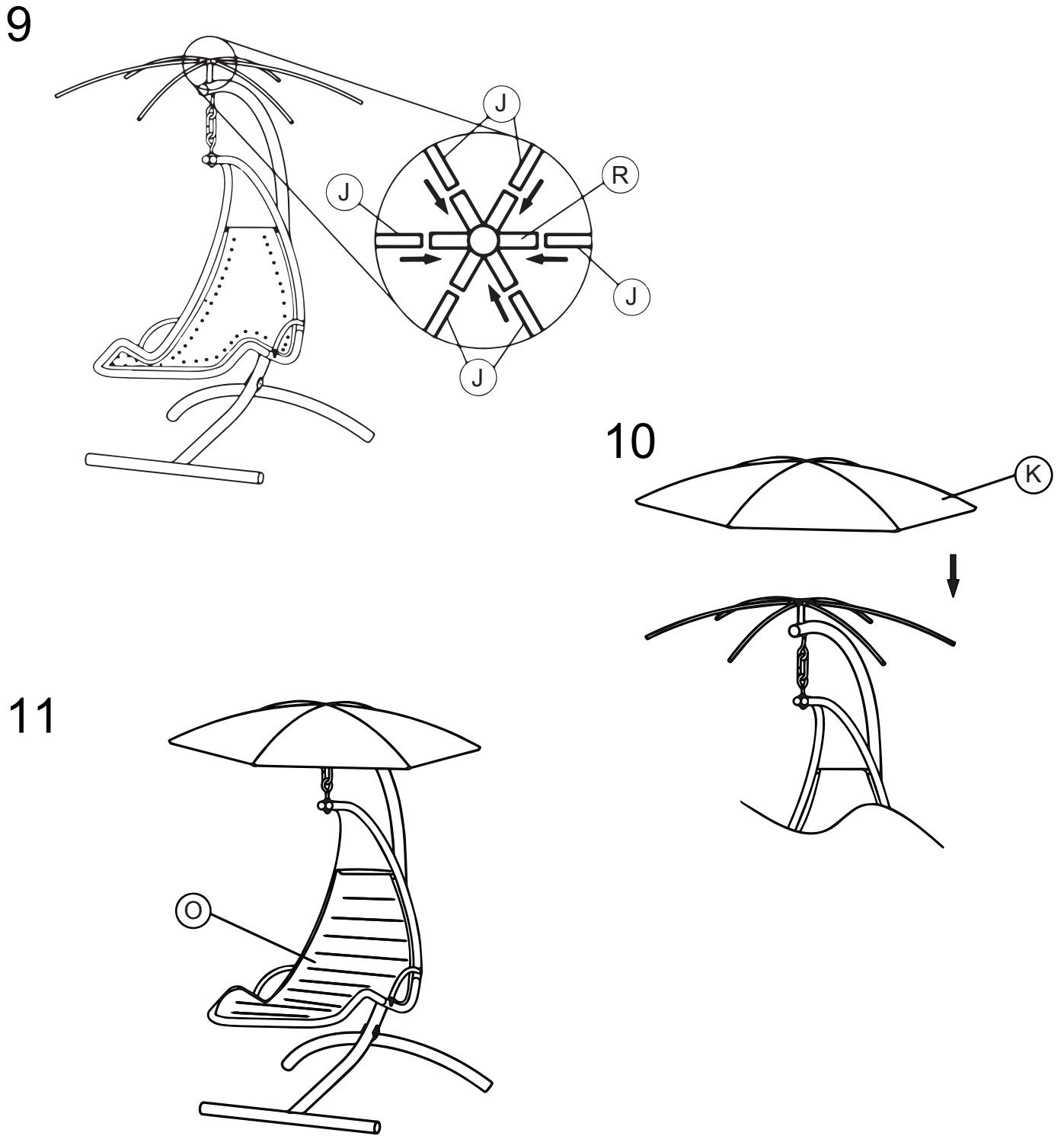

1-YEAR LIMITED WARRANTY

This product is warranted to the original purchaser to be free from defects in material or workmanship for a period of one year from the date of the original retail purchase.

This warranty does not cover defects or damage due to improper installation, alteration, accident or any other event beyond the control of the manufacturer. Defects or damage resulting from misuse, abuse or negligence will void this warranty. This warranty does not cover scratching or damage that may result from normal usage.

This product is not intended for institutional or commercial use; the manufacturer does not assume any liability for such use. Institutional or commercial use will void this warranty.

This warranty is nontransferable and is expressly limited to the repair or replacement of the defective product. During the warranty period, the manufacturer shall repair or replace defective parts at no cost to the purchaser. Shipping charges and insurance are not covered and are the responsibility of the purchaser. Labor charges and related expenses for removal, installation or replacement of the product or components are not covered under this warranty.

The manufacturer reserves the right to make substitutions to warranty claims if parts are unavailable or obsolete.

The manufacturer shall not be liable for loss of use of the product or other consequential or incidental costs, expenses or damages incurred by the consumer of any other use. The user assumes all risk of injury resulting from the use of this product.

This warranty is expressly in lieu of all other warranties, expressed or implied, including warranties of merchantability or fitness for use to the extent permitted by Federal or state law. Neither the manufacturer nor any of its representatives assumes any other liability in connection with this product.

All warranty claims must be made through the retailer where the product was originally purchased. A purchase receipt or other proof of date of purchase will be required to process all warranty claims. The model number and part numbers found within the assembly instructions will be required when submitting any parts requests or warranty claims.

For further warranty information or inquiries, please call 800-759-0977

ACCROCHANT CHAISE LONGUE INSTRUCTIONS D'ASSEMBLAGE



Contactez notre
service à la clientèle au
800-759-0977
avec des questions sur le montage
ou l'utilisation de ce produit.

MERCI!

Merci d'avoir acheté notre produit. Nous travaillons 24 heures sur 24, partout dans le monde, à garantir que nos produits sont de la meilleure qualité possible. Toutefois, dans les rares cas de problèmes lors du montage ou de l'utilisation de ce produit, se il vous plaît communiquer avec notre service à la clientèle au **800-759-0977** pour une aide immédiate avant de contacter votre revendeur. Pour obtenir de plus amples renseignements, veuillez lire l'information relative à la garantie au verso de ce guide d'instructions.

INSTRUCTIONS D'ASSEMBLAGE

IMPORTANT! VEUILLEZ LIRE, EN ENTIER, TOUTES LES INSTRUCTIONS AVANT D'ASSEMBLER VOTRE PRODUIT.

1. Trouver une surface propre et plane, pour commencer le montage de la chaise. La chaise s'assemble à l'envers pour être ensuite retournée sur ses pieds, une fois l'assemblage complété. Cette table est lourde et nécessite au moins deux adultes forts pour la soulever et la retourner.
2. Retirez le contenu de la boîte, avant de commencer l'assemblage, assurez-vous d'avoir toutes les pièces telles que listées et illustrées au tableau d'identification. ***Avis : certaines pièces sont préassemblées ou préinstallées.***
3. Certaines illustrations ou dessins peuvent ne pas ressembler au produit que vous avez acheté.
4. ***Quand vous fixez en place une pièce avec plus d'une vis ou écrou, veuillez, en premier, les visser à la main et terminer la fixation avec un tournevis ou une clé.***
5. Un tournevis électrique peut être utile lors de l'assemblage, mais veuillez le régler à ***basse torque*** et l'utiliser avec prudence; si la torque est trop élevée, la vis peut se défaire ou être trop serrée.

AVERTISSEMENTS!

LIRE TOUTES LES INSTRUCTIONS D'ASSEMBLAGE ET LES CONSIGNES DE SÉCURITÉ ATTENTIVEMENT.

RISQUE D'ÉTOUFFEMENT – CERTAINS ÉLÉMENTS DU PRODUIT CONTIENNENT DE PETITES PIÈCES - NE CONVIENT PAS À UN ENFANT DE MOINS DE TROIS ANS.

ENTRETIEN ET USAGE







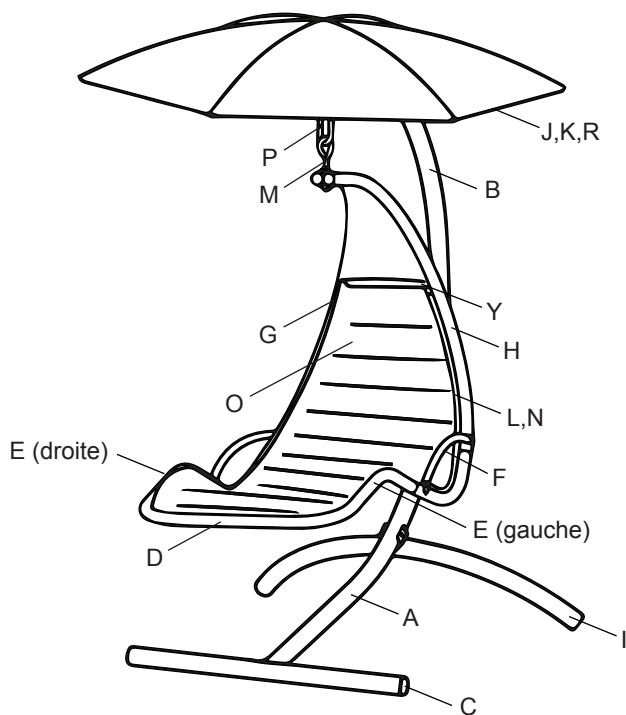



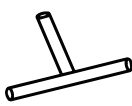
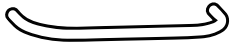
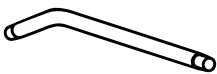

1. Ce produit doit être utilisé **À L'INTÉRIEUR** seulement.
2. **NE JAMAIS** déplacer la chaise en la traînant, cela pourrait endommager les pieds.

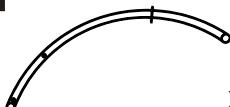
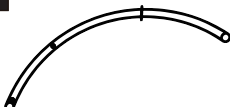
ACCROCHANT CHAISE LONGUE - NU3215, NU3220 & NU3221

liste des pièces

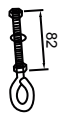

illustrations non à l'échelle









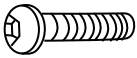

A NUP2020  x1 poteau inférieur	B NUP2021  x1 poteau supérieur	C NUP2022  x1 base avant	D NUP2023  x1 cadre avant
E NUP2024L - Left NUP2024R - Right  x2 connecteur cadre	F NUP2025  x2 attache de cadre de siège	G NUP2026  x1 cadre droit	H NUP2027  x1 cadre gauche
I NUP2028  x1 base arrière	J NUP2029  x6 nervure de parasol	K NUP2030 - beige NUP2039 - terre cuite NUP2040 - kaki  x1 canopée parasol	L NUP2031  x1 siège
M NUP2032  x2 anneau à visser avec rondelle et écrou	N NUP2033  x1 corde	O NUP2034 - beige NUP2041 - terre cuite NUP2042 - kaki  x1 coussin de siège	P NUP2035  x1 lien de connexion

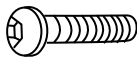
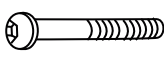
*Pièces incluses dans le sac de quincaillerie NUP2038

ACCROCHANT CHAISE LONGUE - NU3215, NU3220 & NU3221

liste des pièces

illustrations non à l'échelle

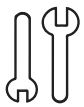
Q NUP2038*  x1 boulon - M8x80mm	R NUP2036  x1 support de parasol	S NUP2038*  x4 boulon - M8x75mm	T NUP2038*  x4 boulon - M8x68mm
U NUP2038*  x11 rondelle	V NUP2038*  x9 écrou	W NUP2038*  1 x2  2 x9 casquette de écrou	X NUP2038*  x2 boulon - M8x20mm
Y NUP2037  x1 croisillon	AA NUP2038*  x1 clé Allen	BB NUP2038*  x2 clé	

*Pièces incluses dans le sac de quincaillerie NUP2038

INSTRUCTIONS D'ASSEMBLAGE

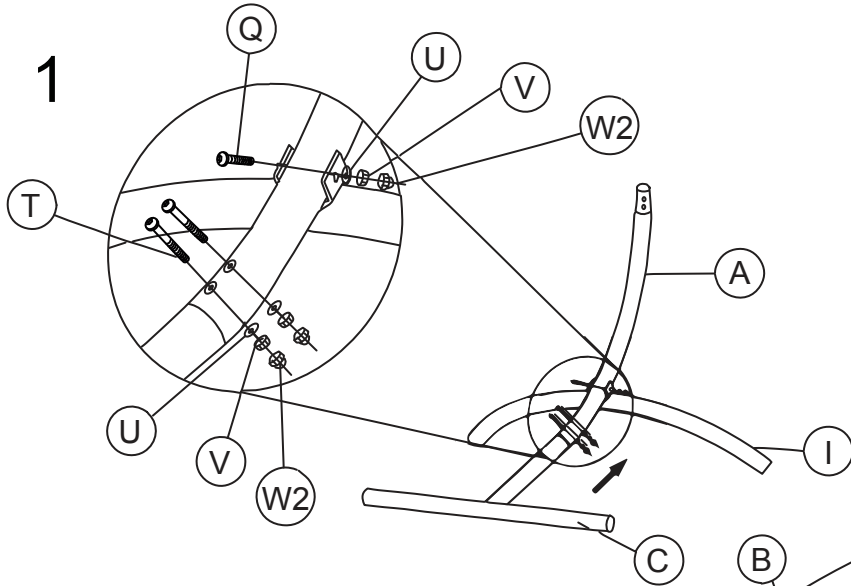

REMARQUE: Serrer à la main tous les boulons en place, puis serrer avec une clé une fois complètement assemblé.

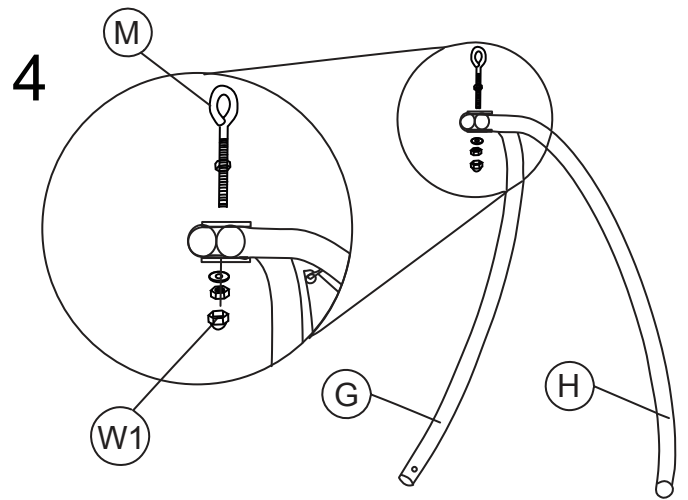
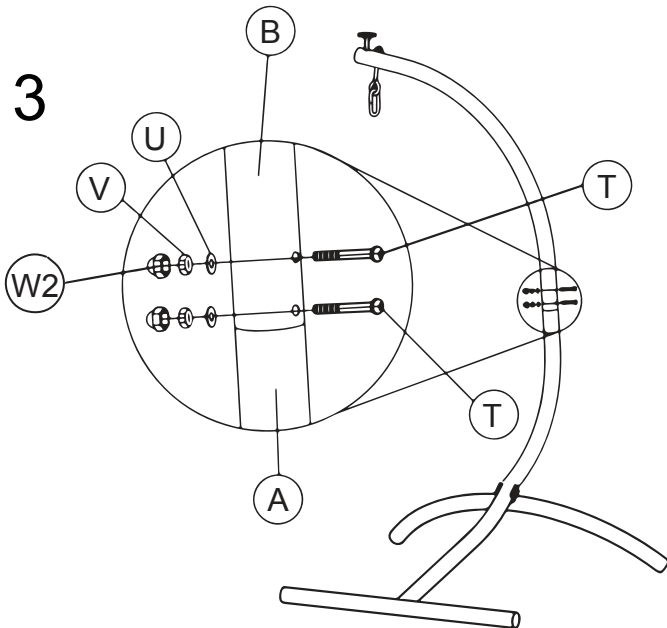
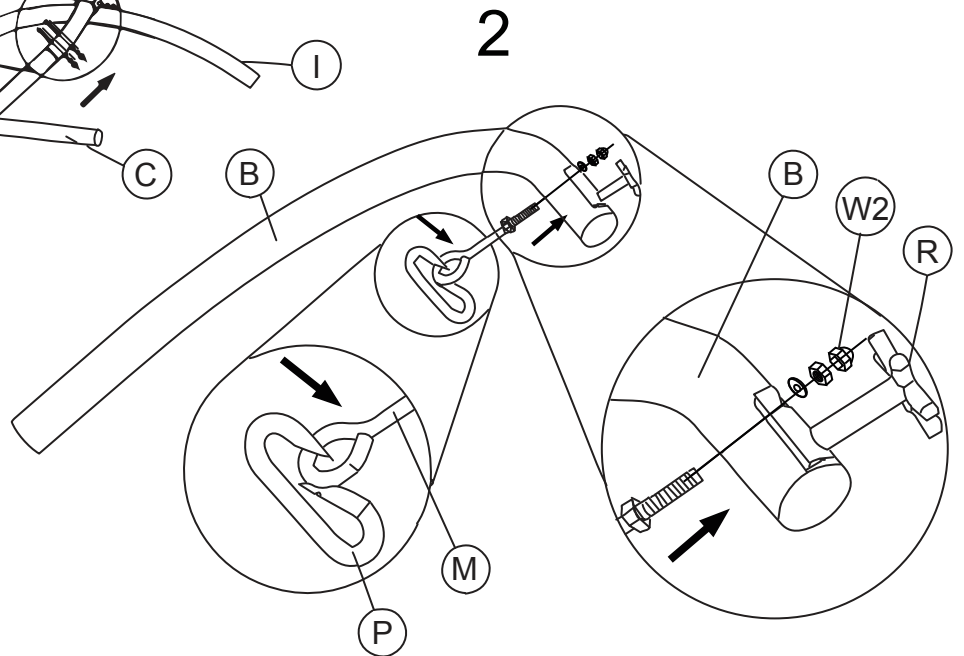

INSTRUCTIONS D'ASSEMBLAGE (suite)

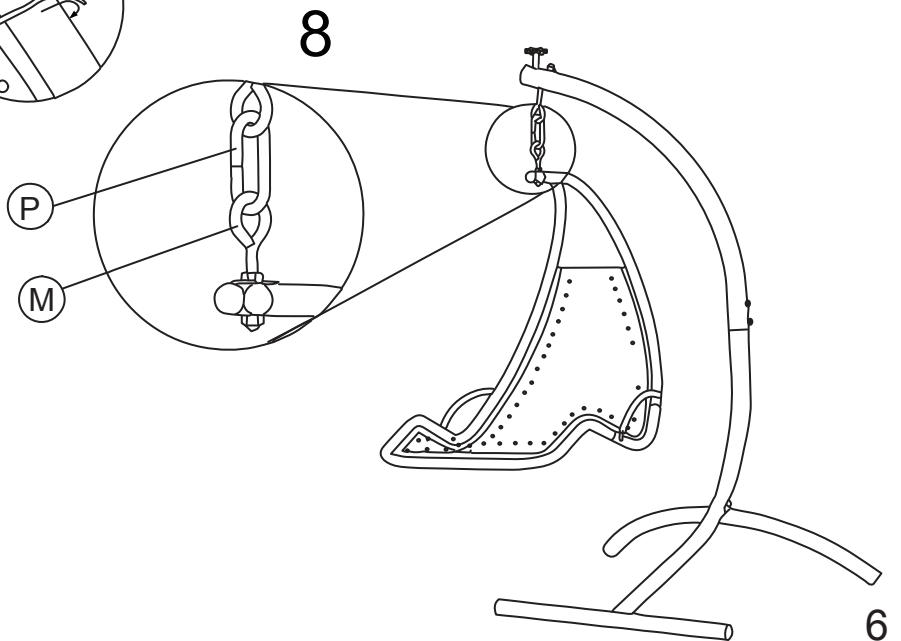
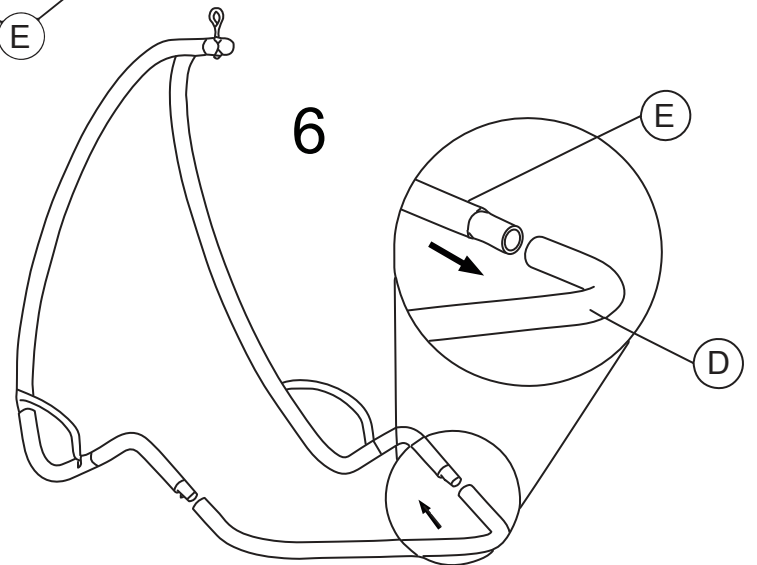
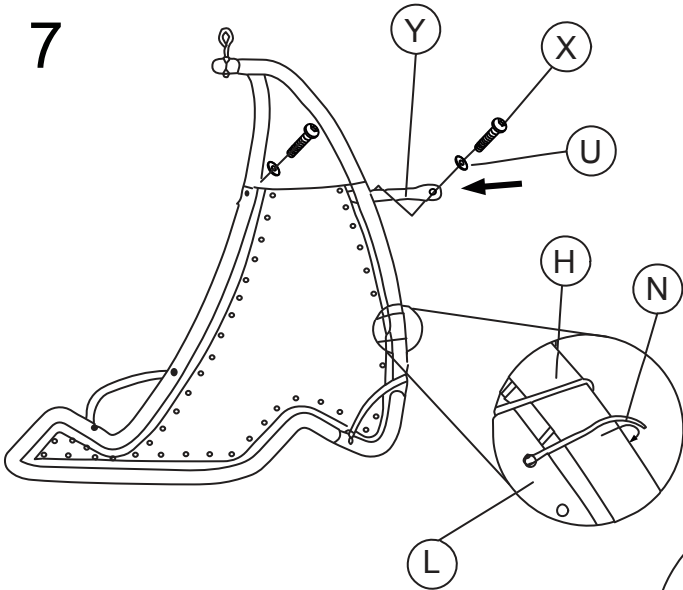
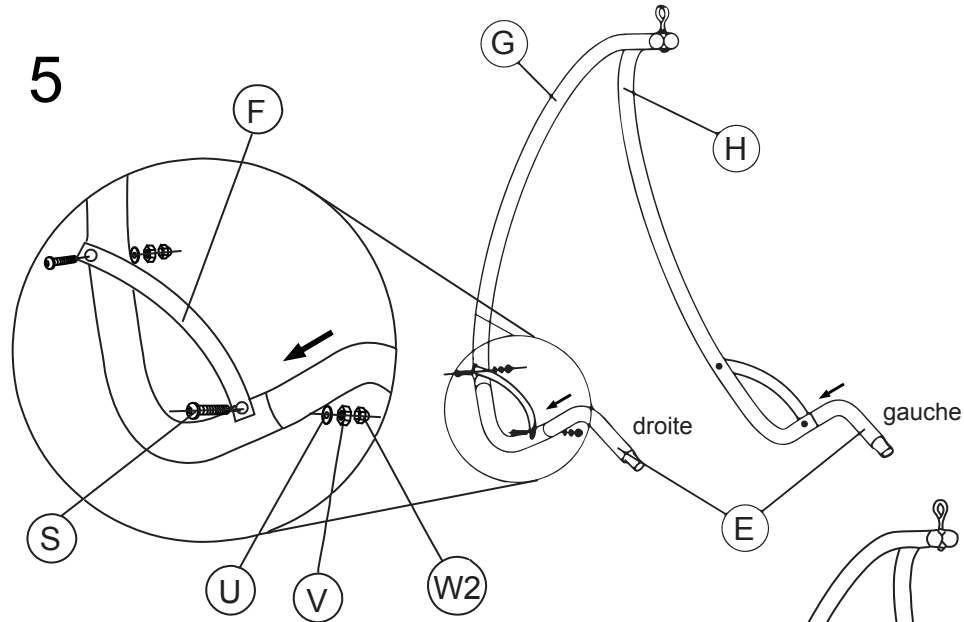

INSTRUCTIONS D'ASSEMBLAGE (suite)

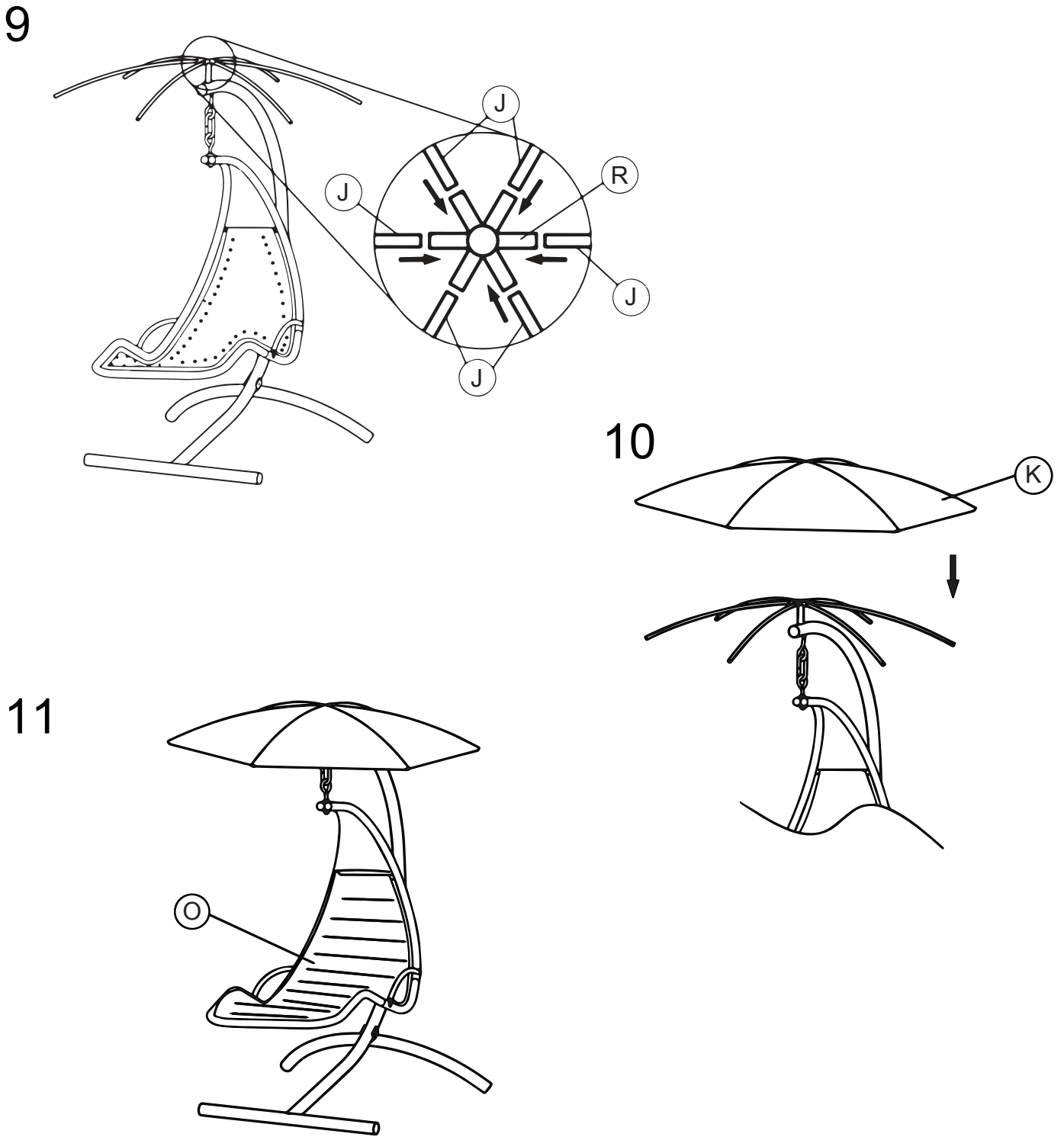

GARANTIE LIMITÉE D'UN AN

La garantie du produit est valide pour l'acheteur original en ce qui a trait aux pièces défectueuses ou à la main-d'œuvre pour une période de d'un an de la date d'achat.

Cette garantie n'est couverte pas les dommages causés par accident, par modification, par une installation défectueuse ou tout autre événement hors du contrôle du fabricant. Tout défaut ou dommage résultant de la négligence ou d'une mauvaise utilisation annule cette garantie. La présente garantie ne couvre pas les égratignures ou les dommages attribuables à un usage normal.

Ce produit n'est pas destiné à un usage institutionnel ou commercial; le fabricant décline toute responsabilité pour une telle utilisation. Un usage institutionnel ou commercial annule cette garantie.

Cette garantie est non transférable et est expressément limitée à la réparation ou au remplacement du produit défectueux. Au cours de la période de garantie, le fabricant s'engage à remplacer et à réparer les pièces défectueuses sans frais pour l'acheteur. Les frais d'assurance et d'expédition ne sont pas couverts et sont à la charge de l'acheteur. Les frais de main-d'œuvre et les dépenses liées au déplacement, à l'installation ou au remplacement du produit ou de ses composantes ne sont pas couverts par cette garantie.

Le fabricant se réserve le droit de faire des substitutions de recours en garantie si la pièce n'est pas disponible ou obsolète.

Le fabricant décline toute responsabilité liée à la perte d'utilisation ainsi que tous les autres coûts directs ou indirects, frais ou dommages encourus par le consommateur qui aurait été causés par une autre utilisation. L'utilisateur assume tous les risques de dommage résultant de l'utilisation de ce produit.

Cette garantie tient lieu expressément de toute autre garantie, exprimée ou implicite, y compris les garanties de qualité marchande ou d'adaptation à un emploi particulier dans la mesure permise par les lois fédérales ou provinciales. Ni le fabricant, ni aucun de ses représentants n'assument aucune autre responsabilité en rapport avec ce produit.

Toute réclamation doit être faite par le détaillant où le produit a été acheté. Une facture ou autre preuve d'achat est nécessaire pour traiter toutes les réclamations de garantie. Le numéro de modèle et les numéros de référence figurant dans les instructions d'assemblage seront exigés lors de la soumission de demande de pièces ou de recours en garantie.

Pour plus d'information ou pour toute question, veuillez téléphoner au 1 800 759-0977.