

LINE	BBQ LINE
MODEL	SST REFRIGERATORS
NUM	

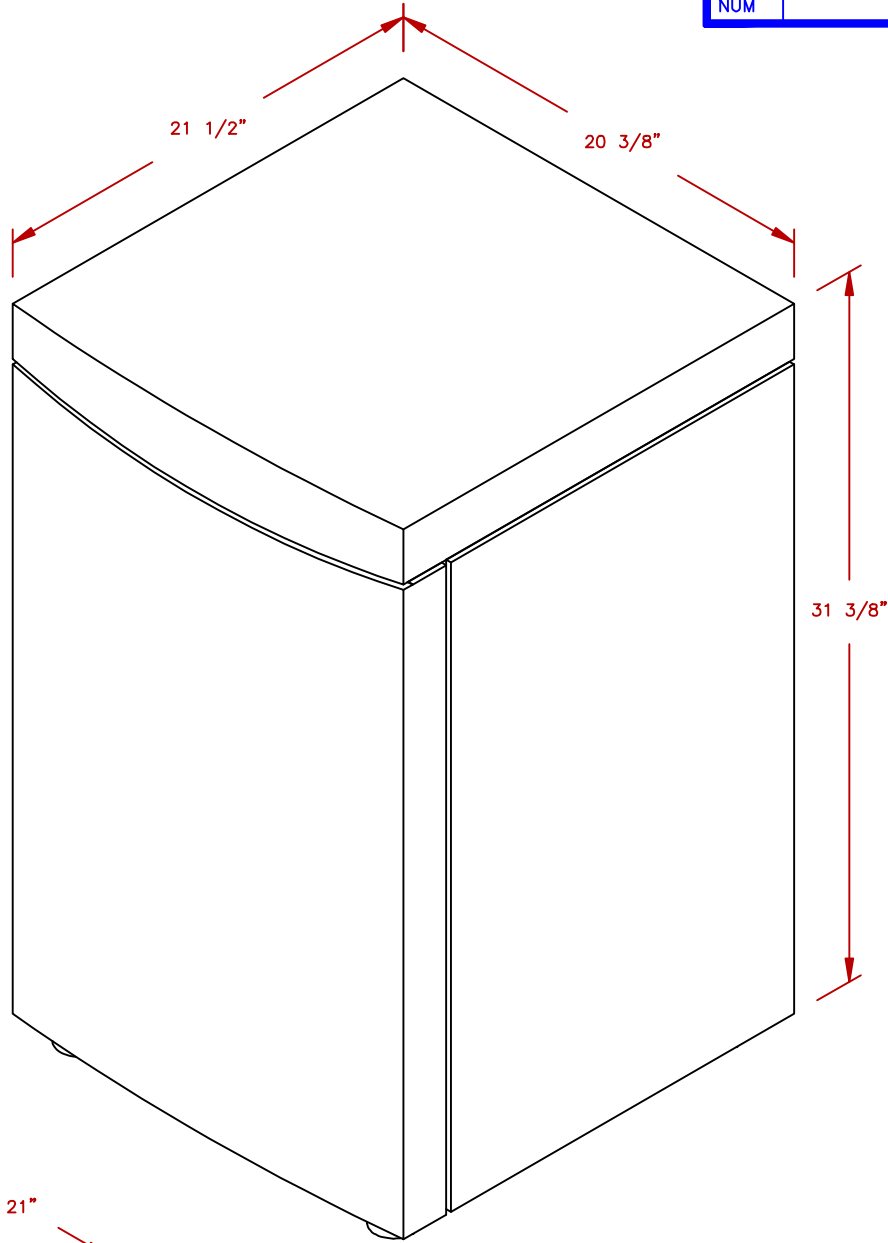

ISOMETRIC VIEW

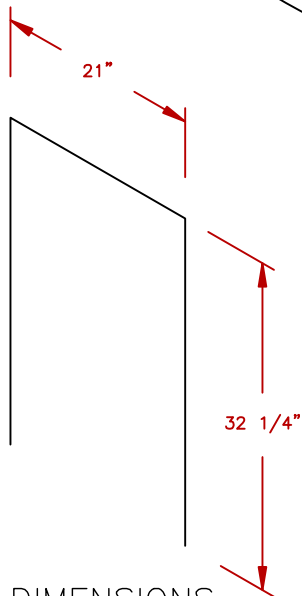

CUT-OUT DIMENSIONS

NOTE:
DUE TO OUR CONTINUOUS IMPROVEMENT PROGRAM, ALL MODELS
AND SPECIFICATIONS ARE SUBJECT TO CHANGE WITHOUT NOTICE.

	TITLE 2019 BARBECUE LINE REFRIGERATOR & ICE MAKER SST REFRIGERATOR	
	SCALE:	DWG NO. BBQ09849P
REVISED	REV. DESCR.	DWG BY J.ORNELAS
		DATE 11/13/18