

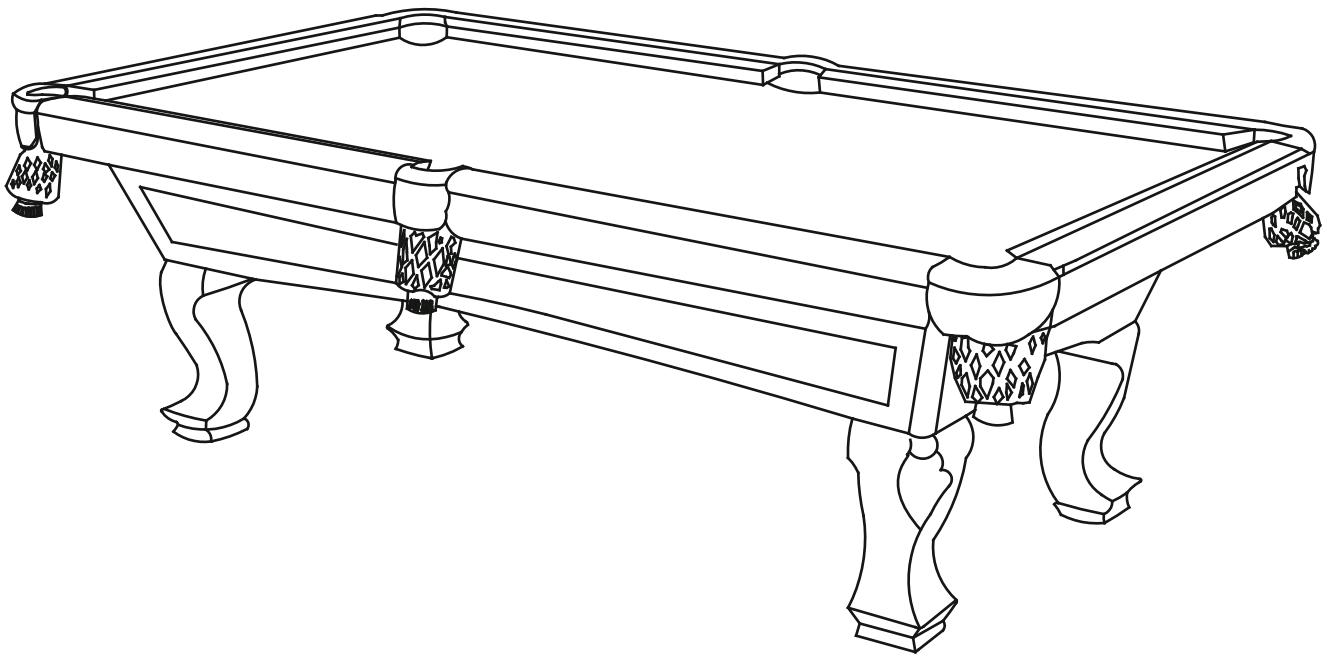





CHAMBERLAIN GAME TABLES

ASSEMBLY INSTRUCTIONS FOR 8' WD B/C POOL TABLE

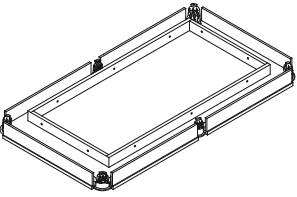
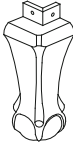
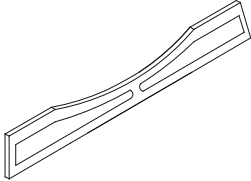
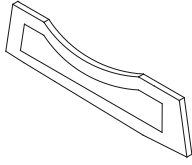
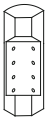
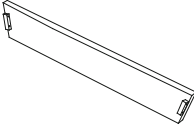
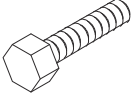
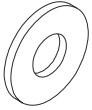
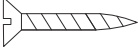

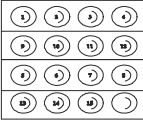
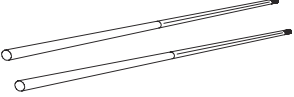
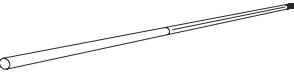
PG-4037/PG-4038

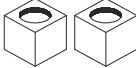
POOL TABLE PART LIST

<p>#1</p>  <p>Main Cabinet 1 piece</p>	<p>#2</p>  <p>Leg 4 pieces</p>	<p>#3</p>  <p>Side Apron 2 pieces</p>	<p>#4</p>  <p>End Apron 2 pieces</p>
<p>#5</p>  <p>Connect Board 4 pieces</p>	<p>#6</p>  <p>Mid Cross Bean 2 pieces</p>	<p>#7</p>  <p>3/8"x50mm Bolt 18 pieces</p>	<p>#8</p>  <p>3/8"x28mm Washer 18 pieces</p>
<p>#9</p>  <p>4x34mm Screw 40 pieces</p>	<p>#10</p>  <p>Bridge Head 1 piece</p>	<p>#11</p>  <p>2-1/4" Pool Ball Set 1 set</p>	<p>#12</p>  <p>2- PC Cue Stick 2 pieces</p>
<p>#13</p>  <p>2-PC Bridge Cue Stick 1 piece</p>	<p>#14</p>  <p>Triangle 1 piece</p>	<p>#15</p>  <p>Chalk 2 pieces</p>	<p>#16</p>  <p>Brush 1 piece</p>

DO NOT SIT ON TABLE!

Assembly Instructions

Step 1:

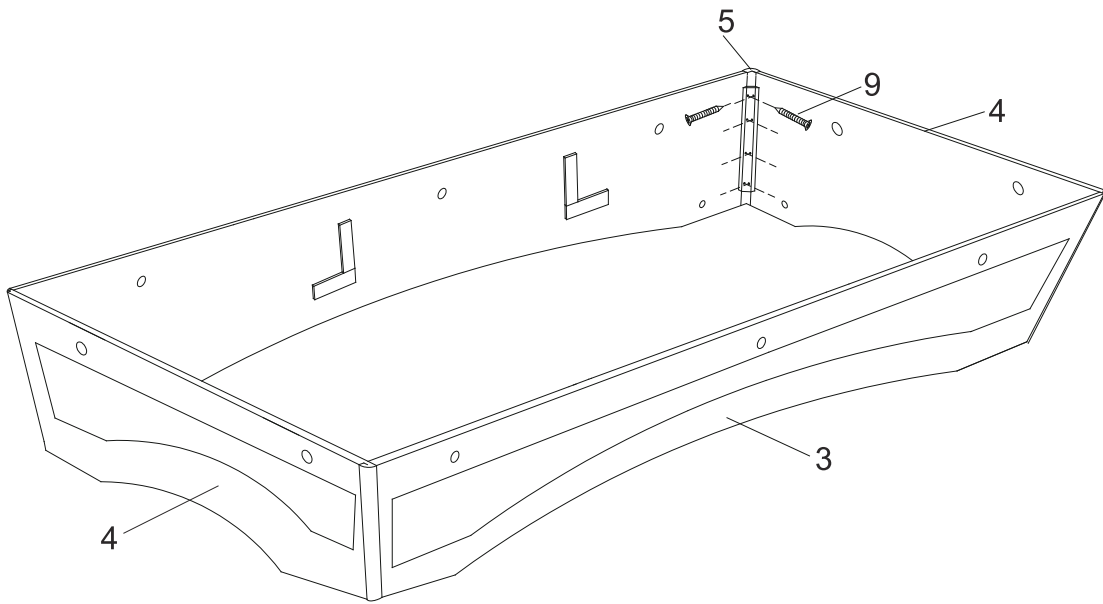

Step 2:

